

AVerMedia[®]
AVerDiGi

EH5108/EH5216 series

EH5108/EH5108⁺/EH5108 Lite

EH5216/EH5216⁺/EH5216 Lite

EH5108H/EH5216H series

EH5108H/EH5108H⁺/EH5108H Lite

EH5216H/EH5216H⁺/EH5216H Lite

EXR5008/EXR5016 series

EXR5008/EXR5008⁺/EXR5008 Lite

EXR5016/EXR5016⁺/EXR5016 Lite

User Manual

FCC NOTICE (Class A)



This device complies with Part 15 of the FCC Rules. Operation is subject to the following two conditions: (1) this device may not cause harmful interference, and (2) this device must accept any interference received, including interference that may cause undesired operation.

Federal Communications Commission Statement

NOTE- This equipment has been tested and found to comply with the limits for a Class A digital device, pursuant to Part 15 of the FCC Rules. These limits are designed to provide reasonable protection against harmful interference in a residential installation. This equipment generates uses and can radiate radio frequency energy and, if not installed and used in accordance with the instructions, may cause harmful interference to radio communications. However, there is no guarantee that interference will not occur in a particular installation. If this equipment does cause harmful interference to radio or television reception, which can be determined by tuning the equipment off and on, the user is encouraged to try to correct the interference by one or more of the following measures:

- Reorient or relocate the receiving antenna.
- Increase the separation between the equipment and receiver.
- Connect the equipment into an outlet on a circuit different from that to which the receiver is connected.
- Consult the dealer or an experienced radio/television technician for help.

Class A ITE

Class A ITE is a category of all other ITE which satisfies the class A ITE limits but not the class B ITE limits. Such equipment should not be restricted in its sale but the following warning shall be included in the instructions for use:

Warning -This is a class A product. In a domestic environment this product may cause radio interference in which case the user may be required to take adequate measures.

European Community Compliance Statement (Class A)



This product is herewith confirmed to comply with the requirements set out in the Council Directives on the Approximation of the laws of the Member States relating to Electromagnetic Compatibility Directive 2004/108/EEC.

Warning - This is a Class A product. In a domestic environment this product may cause radio interference in which case the user may be required to take adequate measures to correct this interference.

DISCLAIMER

No warranty or representation, either expressed or implied, is made with respect to the contents of this documentation, its quality, performance, merchantability, or fitness for a particular purpose. Information presented in this documentation has been carefully checked for reliability; however, no responsibility is assumed for inaccuracies. The information contained in this documentation is subject to change without notice.

In no event will AVerMedia be liable for direct, indirect, special, incidental, or consequential damages arising out of the use or inability to use this product or documentation, even if advised of the possibility of such damages.

TRADEMARKS

AVerMedia, being authorized AVerMedia Information, Inc. to use, is registered trademarks of AVerMedia TECHNOLOGIES, Inc. IBM PC is a registered trademark of International Business Machines Corporation. Macintosh is a registered trademark of Apple Computer, Inc. Microsoft is a registered trademark and Windows is a trademark of Microsoft Corporation. All other products or corporate names mentioned in this documentation are for identification and explanation purposes only, and may be trademarks or registered trademarks of their respective owners.

COPYRIGHT

© 2010 by AVerMedia INFORMATION, Inc. All rights reserved. No part of this publication may be reproduced, transmitted, transcribed, stored in a retrieval system, or translated into any language in any form by any means without the written permission of AVerMedia INFORMATION, Inc.

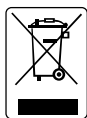

The mark of Crossed-out wheeled bin indicates that this product must not be disposed of with your other household waste. Instead, you need to dispose of the waste equipment by handing it over to a designated collection point for the recycling of waste electrical and electronic equipment. For more information about where to drop off your waste equipment for recycling, please contact your household waste disposal service or the shop where you purchased the product.

Battery Safety Information

- Store the batteries in a cool dry place.
- Do not dispose of used batteries in domestic waste. Dispose of batteries at special collection points or return to point of sale if applies.
- Remove the batteries during long periods of non-use. Always remove exhausted batteries from the remote control. Battery leakage and corrosion can damage this remote control, dispose of batteries safely.
- Do not mix old and new batteries.
- Do not mix different types of batteries: alkaline, standard (carbon-zinc) or rechargeable (nickel-cadmium).
- Do not dispose of batteries in a fire. The batteries may explode or leak.
- Never short circuit the battery terminals.

**WARNING**

TO REDUCE RISK OF FIRE OR ELECTRIC SHOCK, DO NOT EXPOSE THIS APPLIANCE TO RAIN OR MOISTURE

**CAUTION**

IF THERE IS ANY DAMAGE, SHORTAGE OR INAPPROPRIATE ITEM IN THE PACKAGE, PLEASE CONTACT WITH YOUR LOCAL DEALER. WARRANTY VOID FOR ANY UNAUTHORIZED PRODUCT MODIFICATION

**NOTICE**

- INFORMATION IN THIS DOCUMENT IS SUBJECT TO CHANGE WITHOUT NOTICE.
- THE INFORMATION CONTAINED HEREIN IS TO BE CONSIDERED FOR REFERENCE ONLY.

Table of Contents

| | | |
|------------------|--|-----------|
| Chapter 1 | Introduction | 1 |
| 1.1 | Package Content | 1 |
| 1.1.1 | EH5108 series | 1 |
| 1.1.2 | EH5216 series | 2 |
| 1.1.3 | EH5108H series | 3 |
| 1.1.4 | EH5216H series | 4 |
| 1.1.5 | EXR5008/EXR5016 series | 5 |
| 1.1.6 | Optional Accessories | 5 |
| 1.2 | Front Panel | 6 |
| 1.2.1 | EH5108 Lite/EH5108H Lite/EH5216Lite/EH5216H Lite/EXR5008 Lite/EXR5016 Lite | 6 |
| 1.2.2 | EH5108 ⁺ /EH5216 ⁺ /EH5108H ⁺ /EH5216H ⁺ /EXR5008 ⁺ /EXR5016 ⁺ | 6 |
| 1.2.3 | EH5216/EH5108/EXR5008/EXR5016 | 9 |
| 1.2.4 | EH5108H/EH5216H | 9 |
| 1.3 | Back Panel | 12 |
| 1.3.1 | EH5108 series/EH5108H series | 12 |
| 1.3.2 | EH5216 series/EH5216H series | 12 |
| 1.3.3 | EXR5008/EXR5016 series | 13 |
| 1.4 | Setting Up the DVR Unit | 14 |
| 1.4.1 | Installing the Hard Disks | 14 |
| 1.4.2 | Connecting Devices | 19 |
| 1.4.2.1 | EH5108 series/EH5108H series | 19 |
| 1.4.2.2 | EH5216 series/EH5216H series | 21 |
| 1.4.2.3 | EXR5016 series | 23 |
| 1.5 | Sensor, Relay and RS485 pinhole allocation | 25 |
| 1.5.1 | EH series | 25 |
| 1.5.1.1 | Sensor Pin Definition | 25 |
| 1.5.1.2 | Relay Pin Definition | 25 |
| 1.5.1.3 | RS485 Pin Definition | 25 |
| 1.5.2 | EXR series | 26 |
| 1.5.2.1 | Sensor Pin Definition | 26 |
| 1.5.2.2 | Relay Pin Definition | 26 |
| 1.6 | Familiarizing the Remote Control Buttons | 27 |
| Chapter 2 | Using the DVR Software | 30 |
| 2.1 | The Way to Operate DVR | 30 |
| 2.1.1 | First Time Using the DVR Unit | 30 |
| 2.1.2 | Using the Virtual Keyboard | 31 |
| 2.2 | Familiarizing the Buttons in Preview Mode | 32 |
| 2.2.1 | Setting Up and Using the Emap | 33 |
| 2.2.2 | Familiarizing the Buttons in PTZ Camera Controller | 34 |
| 2.2.2.1 | Setup the Analog PTZ Camera | 35 |

| | | |
|------------------|--|-----------|
| 2.2.2.2 | Setup the IP PTZ Camera | 36 |
| 2.2.3 | Using Event Log Viewer | 37 |
| 2.3 | Familiarizing the Buttons in Playback Mode | 38 |
| 2.3.1 | To Cut and Save the Portion of the Recorded Video | 40 |
| 2.3.2 | To Bookmark a Video Section | 40 |
| 2.3.3 | Using Visual Search | 41 |
| 2.3.4 | Using the Event Search..... | 42 |
| Chapter 3 | Customizing the DVR System | 43 |
| 3.1 | System Setup | 43 |
| 3.2 | Camera Setup..... | 49 |
| 3.2.1 | To Setup IP Camera(For EH series) | 49 |
| 3.2.2 | To Setup IP Camera(For EXR series)..... | 52 |
| 3.2.3 | To Setup Analog Camera(For EH series Only) | 55 |
| 3.2.4 | To Setup Camera from the Remote DVR | 56 |
| 3.3 | Recording Setup | 57 |
| 3.3.1 | Setup IP Camera Record Setting | 57 |
| 3.3.2 | Setup Analog Camera Record Setting(For EH series Only) | 58 |
| 3.4 | Network Setup | 60 |
| 3.5 | Schedule Setting..... | 63 |
| 3.6 | Backup Setup | 64 |
| 3.6.1 | Using QPlayer to Playback Backup Video..... | 65 |
| 3.6.2 | To Cut and Save the Portion of the Recorded Video | 67 |
| 3.6.3 | To Search Using the Event Search..... | 67 |
| 3.6.4 | To Search Using the Intelligent Search | 68 |
| 3.7 | Sensor Setting | 69 |
| 3.8 | Relay Setting | 70 |
| 3.9 | Alarm Setting | 71 |
| 3.10 | User Setup..... | 76 |
| Chapter 4 | Using the UPC to Playback Backup File..... | 78 |
| 4.1 | Recommended System Requirements | 78 |
| 4.2 | Installing the USB Playback Console..... | 78 |
| 4.3 | Familiarizing the Buttons in USB Playback Console..... | 79 |
| 4.3.1 | To Cut and Save the Portion of the Recorded Video | 81 |
| 4.3.2 | Playback DVR Recorded File from Hard Disk | 82 |
| 4.3.3 | Playback Backup File(*.dvr) | 83 |
| 4.3.4 | To Backup Recorded File | 84 |
| 4.3.5 | To Search Using the Visual Search | 85 |
| 4.3.6 | To Search Using the Event Search..... | 86 |
| 4.3.7 | To Search Using the Intelligent Search | 86 |
| Chapter 5 | iEnhance | 87 |
| 5.1 | To Use iStable | 88 |
| Chapter 6 | Using the Remote Programs | 89 |
| 6.1 | Familiarizing the Buttons in WebViewer..... | 90 |

| | | |
|------------------|---|------------|
| 6.1.1 | To Setup Remote System Setting..... | 92 |
| 6.1.1.1 | System Setting..... | 92 |
| 6.1.1.2 | Camera Setting..... | 94 |
| 6.1.1.3 | Record Setting..... | 98 |
| 6.1.1.2 | Network Setting..... | 102 |
| 6.1.1.3 | Alarm Setting..... | 104 |
| 6.2 | Familiarizing the Buttons in WebViewer PTZ..... | 108 |
| 6.3 | Familiarizing the Buttons in Remote Console..... | 109 |
| 6.3.1 | To Setup Remote Console Setting..... | 110 |
| 6.3.2 | Familiarizing the Buttons in PTZ Camera Controller..... | 111 |
| 6.4 | Using the Remote Playback..... | 112 |
| 6.4.1 | Familiarizing the Buttons in Local Playback..... | 113 |
| 6.4.1.1 | To Cut and Save the Wanted Portion of the Recorded Video..... | 114 |
| 6.4.2 | Familiarizing the Buttons in RealTime Playback..... | 115 |
| 6.4.3 | Familiarizing the Buttons in Download and Playback..... | 117 |
| Chapter 7 | Using HandyViewer to Access DVR server..... | 118 |
| 7.1 | Using PDAViewer to Access DVR Server..... | 118 |
| 7.1.1 | To Install PDAViewer thru ActiveSync..... | 118 |
| 7.1.2 | To Install PDAViewer from the Internet..... | 119 |
| 7.1.3 | To Use the PDAViewer..... | 120 |
| 7.1.4 | To Playback in PDAViewer..... | 121 |
| 7.2 | Using JavaViewer to Access DVR Server..... | 123 |
| 7.2.1 | To install JavaViewer from the DVR Server..... | 123 |
| 7.2.2 | To Use the JavaViewer..... | 123 |
| Chapter 8 | Using the Web Tools..... | 125 |
| 8.1 | Dispatch Server..... | 125 |
| 8.1.1 | To Run Dispatch program:..... | 125 |
| 8.2 | Remote Setup..... | 126 |
| 8.2.1 | To Add DVR server..... | 126 |
| 8.2.2 | To Setup Remote System Setting..... | 127 |
| 8.2.2.1 | System Setting..... | 127 |
| 8.2.2.2 | Camera Setting..... | 129 |
| 8.2.2.3 | Record Setting..... | 133 |
| 8.2.2.4 | Network Setting..... | 137 |
| 8.2.2.5 | Alarm Setting..... | 139 |
| 8.3 | Remote Backup..... | 143 |
| 8.3.1 | To back up the recoded data from the DVR server:..... | 143 |
| Appendix A | Registering Domain Name..... | 146 |
| Appendix B | Network Service Port..... | 147 |
| Appendix C | Using Functional Keys..... | 148 |

1.1 Package Content

1.1.1 EH5108 series



a



b
(1)



c



(2)



(3)



(4)



(5)



(6)

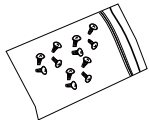

(7)

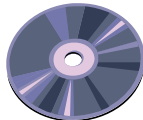

(8)

- (1) DVR unit
 - a. EH5108
 - b. EH5108⁺
 - c. EH5108 Lite
- (2) AVerMedia USB optical mouse
- (3) Quick Installation Guide
- (4) Power adaptor
- (5) Power Cord
- * The power cord varies depending on the standard power outlet of the country where it is sold.
- (6) SATA cables
- (7) Screws for HDD installation
- (8) Software CD (User Manual included)

1.1.2 EH5216 series



a



b
(1)



c



(2)



(3)



(4)



(5)



(6)

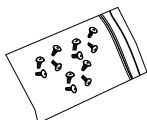

(7)

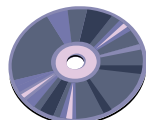

(8)

(1) DVR unit

a. EH5216

b. EH5216⁺

c. EH5216 Lite

(2) AVerMedia USB optical mouse

(3) Quick Installation Guide

(4) Power adaptor

(5) Power Cord

* The power cord varies depending on the standard power outlet of the country where it is sold.

(6) SATA cables

(7) Screws for HDD installation

(8) Software CD (User Manual included)

1.1.3 EH5108H series



a



b



c

(1)



(2)



(3)



(4)



(5)



(6)

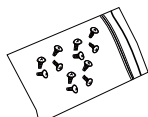

(7)



(8)



(9)

- (1) DVR unit
 - a. EH5108H
 - b. EH5108H⁺
 - c. EH5216H Lite
- (2) AVerMedia USB optical mouse
- (3) Quick Installation Guide
- (4) Power adaptor
- (5) Power Cord
 - * The power cord varies depending on the standard power outlet of the country where it is sold.
- (6) SATA cables
- (7) Screws for HDD installation
- (8) Software CD (User Manual included)
- (9) Audio cable (Red cable: 8CH audio in/White cable: 1CH audio out/Black cable: 1CH MIC in)

1.1.4 EH5216H series



a



b

(1)



c



(2)



(3)



(4)



(5)



(6)

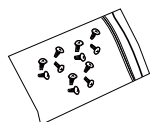

(7)



(8)



(9)

- (1) DVR unit
 - a. EH5216H
 - b. EH5216H⁺
 - c. EH5216H Lite
- (2) AVerMedia USB optical mouse
- (3) Quick Installation Guide
- (4) Power adaptor
- (5) Power Cord
 - * The power cord varies depending on the standard power outlet of the country where it is sold.
- (6) SATA cables
- (7) Screws for HDD installation
- (8) Software CD (User Manual included)
- (9) Audio cable (Red cable: 16CH audio in/White cable: 1CH audio out/Black cable: 1CH MIC in)

1.1.5 EXR5008/EXR5016 series



a



b
(1)



c



(2)



(3)



(4)



(5)



(6)

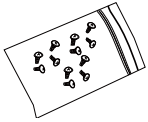

(7)

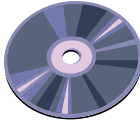

(8)

- (1) DVR unit
 - a. EXR5008/EXR5016
 - b. EXR5008+/EXR5016+
 - c. EXR5008 Lite/EXR5016 Lite
- (2) AVerMedia USB optical mouse
- (3) Quick Installation Guide
- (4) Power adaptor
- (5) Power Cord
- * The power cord varies depending on the standard power outlet of the country where it is sold.
- (6) SATA cables
- (7) Screws for HDD installation
- (8) Software CD (User Manual included)

1.1.6 Optional Accessories



Remote controller



DVI cable (16CH Loop out cable)
For EH5216/EH5216H series



Audio Cable
(for EH5216 series)



Audio Cable
(for EH5108 series)



Audio cable for EXR5008/EXR5016 series
(White: 1CH audio out
Black: 1CH MIC in)



Rack ears

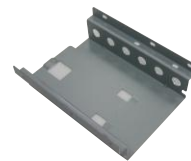

HDD Holder for 4th hard disk
(SATA cable is included)



IR extended cable



90W power adaptor for 3rd and 4th hard disk
(for EXR5008/5016 Lite only)

1.2 Front Panel





1.2.1 EH5108 Lite/EH5108H Lite/EH5216Lite/EH5216H Lite EXR5008 Lite/EXR5016 Lite

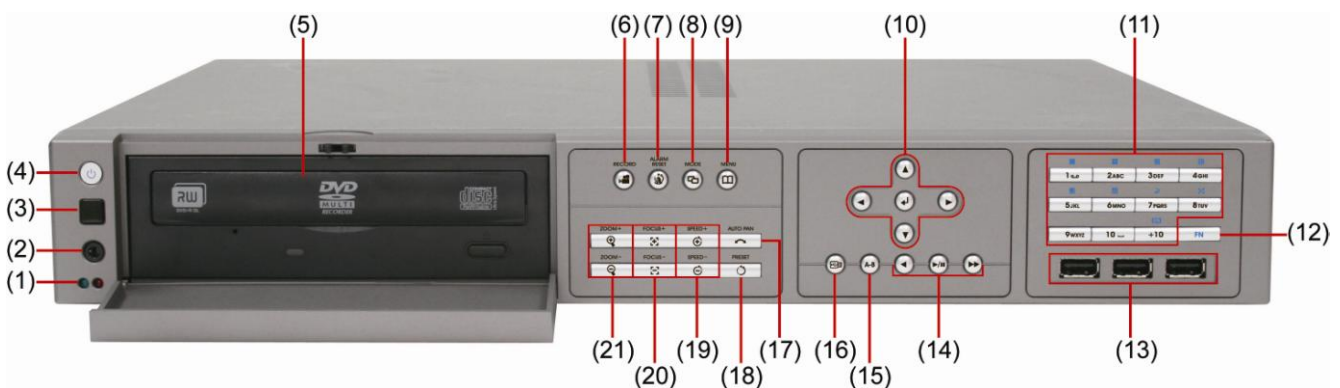

| Name | Function |
|----------------------------|--|
| (1) System Power indicator | System power status indicators. Indicate running state of system. Lights when the system is running. |
| (2) Record indicator | When DVR system is recording, the light will keep flashing. |
| (3) Power | ON/OFF DVR unit |
| (4) IR Sensor | Receive signal from the remote control to operate the DVR unit |
| (5) IR Sensor port | For extended IR sensor cable connection(optional) |
| (6) USB 2.0 port | 3 x USB 2.0 ports for connecting USB device, ex: USB pen drive, external hard disk, mouse...and so on. |
| |  The USB storage device must be in FAT32 format. |

1.2.2 EH5108⁺/EH5216⁺/EH5108H⁺/EH5216H⁺/EXR5008⁺/EXR5016⁺



| Name | Function |
|---|---|
| (1) System indicator | - Power indicator (left): System power status indicators. Indicate running state of system. Lights when the system is running. - Record indicator (right): When DVR system is recording, the light will keep flashing. |
| (2) IR Sensor port | For extended IR sensor cable connection(optional) |
| (3) IR Sensor | Receive signal from the remote control to operate the DVR unit |
| (4) Power | ON/OFF DVR unit |
| (5) DVD-ROM | To backup the recorded file to DVD±R/DVD±RW disk  CD-R/RW is not supported. |
| (6)  | To start recording video |
| (7)  | To reset alarm status |
| (8)  | Switch to playback mode or preview mode |

| Name | Function |
|----------------------|---|
| (9) | Call out system setup menu on preview mode |
| (10) Control Buttons | Move to left direction on menu control To move PTZ camera lens to left in PTZ mode |
| | Move to right direction on menu control To move PTZ camera lens to right in PTZ mode |
| | To move PTZ camera lens to up Move to up direction on menu control |
| | To move PTZ camera lens to down Move to down direction on menu control |
| | Confirm or make a selection |

- Channel camera selection number in playback and preview mode. For the channel over 10, press , then press ~ .

- Press , and then press can switch to character mode.

- Press button can switch to different screen display modes (~).

- Press and number button, to set the preset position in the PTZ mode.



(11) Number buttons

- Switch to character mode.

- Press to switch to FN mode (The word "FN" will show up in the left bottom corner on screen). And then, press to enter EN mode (The word "EN" will show up in the left bottom corner on screen). User can press the character button and press rapidly to find the character that wants to enter.

: backward/delete button

: abcABC

: edfDEF

: ghiGHI

: jklJKL

: mnoMNO









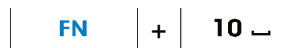











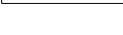

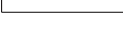









: pqrsPQRS

: tuvTUV

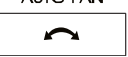
: wxyzWXYZ

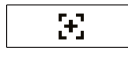
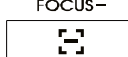

: space button



| Name | Function |
|--|---|
| (12)  | <p>A functional key for multiple system control. Press  to switch to FN mode (The word “FN” will show up in the left bottom corner on screen). Press  button again to exit FN mode (The “X” will show up in the left bottom corner on screen).</p> <p> +  : Switch to single screen display mode</p> <p> +  : Switch to QUAD display mode</p> <p> +  : Switch to 9 split screen display mode</p> <p> +  : Switch to 16 split screen display mode</p> <p> +  : Switch to one single and 7 + 1 split screen display mode</p> <p> +  : Switch to one single and 12+ 1 split screen display mode</p> <p> +  : Enable/disable auto scan</p> <p> +  : Switch to full screen mode</p> <p> +  : Switch to characters mode</p> |
| (13) USB 2.0 port | <p>3 x USB 2.0 ports for connecting USB device, ex: USB pen drive, external hard disk, mouse...and so on.</p> <p> The USB storage device must be in FAT32 format.</p> |
| (14) Playback buttons | <p> To playback video at faster speed</p> <p> To start playback To pause playback</p> <p> To rewind the recorded video</p> |
| (15)  | Set a video segment to playback repeat |
| (16)  | To backup recorded video file to USB storage device(pen drive or external hard disk) and DVD-ROM. |
| (17) Auto Pan | <p>AUTO PAN</p> <p> To enable auto pan function</p> |
| (18) Preset | <p>PRESET</p> <p> Adjust the PTZ lens to the position that user wants. And then, press  with number button to setup the PTZ camera preset position.</p> |
| (19) Speed + / Speed - | <p>SPEED +</p> <p> To speed up movement of PTZ camera lens</p> <p>SPEED -</p> <p> To speed down movement of PTZ camera lens</p> |
| (20) Focus + / Focus - | <p>FOCUS+</p> <p> To focus in PTZ camera lens</p> <p>FOCUS-</p> <p> To focus out PTZ camera lens</p> |
| (21) Zoom + / Zoom - | <p>ZOOM+</p> <p> To zoom in view of PTZ camera lens</p> <p>ZOOM-</p> <p> To zoom out view of PTZ camera lens</p> |





1.2.3 EH5216/EH5108/EXR5008/EXR5016

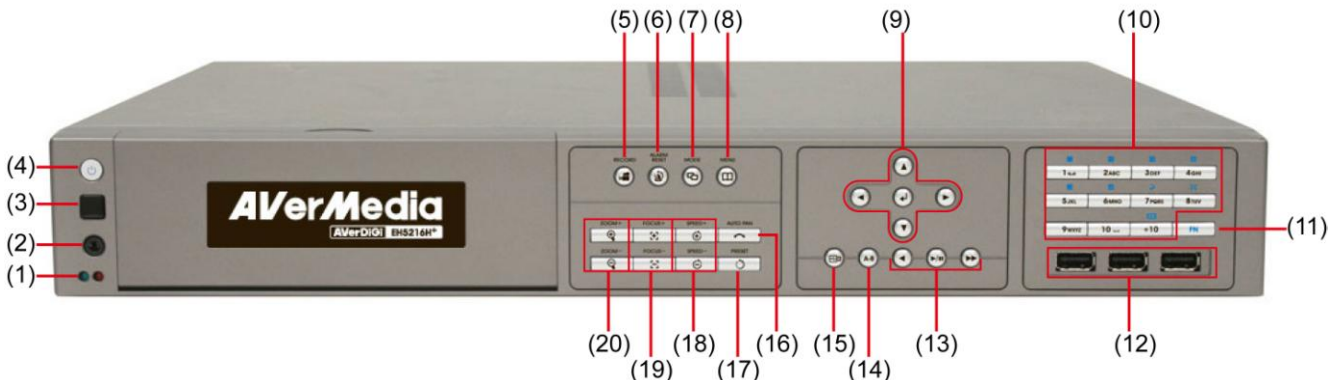

| Name | Function |
|----------------------|---|
| (1) System indicator | <ul style="list-style-type: none"> - Power indicator (left): System power status indicators. Indicate running state of system. Lights when the system is running. - Record indicator (right): When DVR system is recording, the light will keep flashing. |
| (2) IR Sensor port | For extended IR sensor cable connection(optional) |
| (3) IR Sensor | Receive signal from the remote control to operate the DVR unit |
| (4) Power | ON/OFF DVR unit |
| (5) DVD-ROM | To backup the recorded file to DVD±R/DVD±RW disk  CD-R/RW is not supported. |
| (6) USB 2.0 port | 3 x USB 2.0 ports for connecting USB device, ex: USB pen drive, external hard disk, mouse...and so on.  The USB storage device must be in FAT32 format. |

1.2.4 EH5108H/EH5216H



| Name | Function |
|---|---|
| (1) System indicator | <ul style="list-style-type: none"> - Power indicator (left): System power status indicators. Indicate running state of system. Lights when the system is running. - Record indicator (right): When DVR system is recording, the light will keep flashing. |
| (2) IR Sensor port | For extended IR sensor cable connection(optional) |
| (3) IR Sensor | Receive signal from the remote control to operate the DVR unit |
| (4) Power | ON/OFF DVR unit |
| (5)  | To start recording video |
| (6)  | To reset alarm status |
| (7)  | Switch to playback mode or preview mode |
| (8)  | Call out system setup menu on preview mode |

| Name | Function |
|---------------------|---|
| (9) Control Buttons | Move to left direction on menu control To move PTZ camera lens to left in PTZ mode |
| | Move to right direction on menu control To move PTZ camera lens to right in PTZ mode |
| | To move PTZ camera lens to up Move to up direction on menu control |
| | To move PTZ camera lens to down Move to down direction on menu control |
| | Confirm or make a selection |

- Channel camera selection number in playback and preview mode. For the channel over 10, press , then press ~ .

- Press , and then press can switch to character mode.

- Press button can switch to different screen display modes (~).

- Press and number button, to set the preset position in the PTZ mode.

- Switch to character mode.

- Press to switch to FN mode (The word "FN" will show up in the left bottom corner on screen). And then, press to enter EN mode (The word "EN" will show up in the left bottom corner on screen). User can press the character button and press rapidly to find the character that wants to enter.

(10) Number buttons

+

: backward/delete button

: abcABC

: edfDEF

: ghiGHI

: jklJKL

























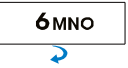









: mnoMNO

: pqrPQRS

: tuvTUV

: wxyzWXYZ

: space button

| Name | Function |
|------|--|
| (11) | <p>A functional key for multiple system control. Press  to switch to FN mode (The word “FN” will show up in the left bottom corner on screen). Press  button again to exit FN mode(The “X” will show up in the left bottom corner on screen).</p> <p> +  : Switch to single screen display mode</p> <p> +  : Switch to QUAD display mode</p> <p> +  : Switch to 9 split screen display mode</p> <p> +  : Switch to 16 split screen display mode</p> <p> +  : Switch to one single and 7 + 1 split screen display mode</p> <p> +  : Switch to one single and 12+ 1 split screen display mode</p> <p> +  : Enable/disable auto scan</p> <p> +  : Switch to full screen mode</p> <p> +  : Switch to characters mode</p> |
| (12) | <p>3 x USB 2.0 ports for connecting USB device, ex: USB pen drive, external hard disk, mouse...and so on.</p> <hr/> <p> The USB storage device must be in FAT32 format.</p> |
| (13) | <p> To playback video at faster speed</p> <hr/> <p> To start playback To pause playback</p> <hr/> <p> To rewind the recorded video</p> |
| (14) | <p> Set a video segment to playback repeat</p> |
| (15) | <p> To backup recorded video file to USB storage device(pen drive or external hard disk) and DVD-ROM.</p> |
| (16) | <p>AUTO PAN  To enable auto pan function</p> |
| (17) | <p>PRESET  Adjust the PTZ lens to the position that user wants. And then, press  with number button to setup the PTZ camera preset position.</p> |
| (18) | <p>SPEED+  To speed up movement of PTZ camera lens</p> <p>SPEED-  To speed down movement of PTZ camera lens</p> |
| (19) | <p>FOCUS+  To focus in PTZ camera lens</p> <p>FOCUS-  To focus out PTZ camera lens</p> |
| (20) | <p>ZOOM+  To zoom in view of PTZ camera lens</p> <p>ZOOM-  To zoom out view of PTZ camera lens</p> |

1.3 Back Panel

1.3.1 EH5108 series/EH5108H series

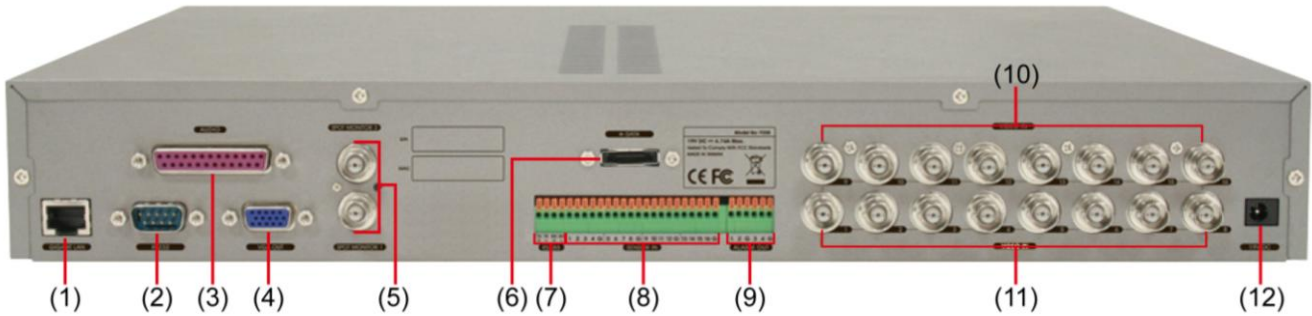

| Name | Function |
|--|--|
| (1) LAN Port | For Gigabit Ethernet connection |
| (2) RS232 port | For POS device connection |
| (3) Audio In/Out/MIC In | Output the audio signal to audio output device |
| <p>i The audio input and output device has its own power supply is necessary.</p> | |
| (4) VGA Out | Output the video signal to a CRT or LCD monitor |
| (5) SPOT Monitor 1/2 | Output the video signal to SPOT monitor when receive the alarm events |
| (6) eSATA port | For connecting with eSATA RAID |
| (7) RS485 | For analog PTZ camera connection (also see Chapter 1.6) |
| (8) Sensor In | Support up to 16 sensor devices |
| (9) Relay Out | Support 4 relay devices (Relay: 1A @ 125V AC/30V DC) |
| (10) Video Loop Out | Output the video signal to a CCTV monitor. Only output one channel signal at a time. |
| (11) CH1~ 8 | Input the video camera signal and display it on channel 1~ 8 |
| (12) 19V DC connector | Connect the power cord into this port |

1.3.2 EH5216 series/EH5216H series

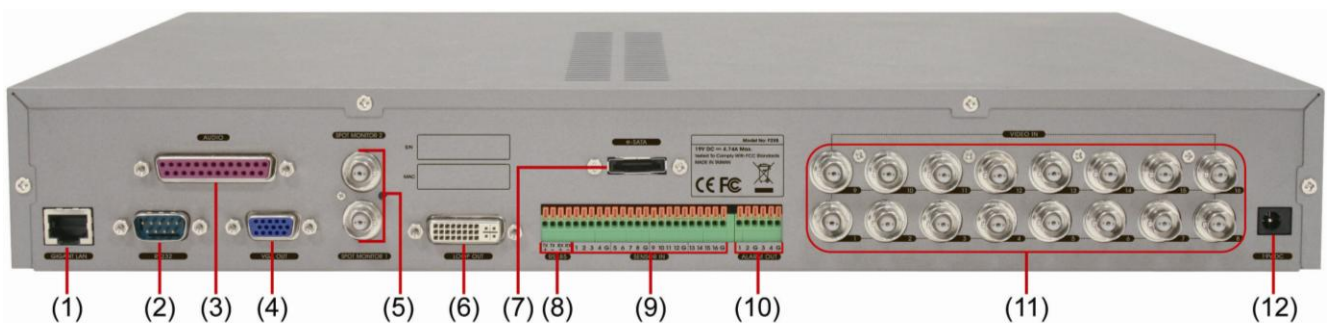

| Name | Function |
|--|--|
| (1) LAN Port | For Gigabit Ethernet connection |
| (2) RS232 port | For POS device connection |
| (3) Audio In/Out/MIC In | Output the audio signal to audio output device |
| <p>i The audio input and output device has its own power supply is necessary.</p> | |
| (4) VGA Out | Output the video signal to a CRT or LCD monitor |
| (5) SPOT Monitor 1/2 | Output the video signal to SPOT monitor when receive the alarm events |
| (6) Video Loop Out | Output the video signal to a CCTV monitor. Only output one channel signal at a time. |

| Name | Function |
|-----------------------|--|
| (7) eSATA port | For connecting with eSATA RAID |
| (8) RS485 | For analog PTZ camera connection (also see Chapter 1.6) |
| (9) Sensor In | Support up to 16 sensor devices |
| (10) Relay Out | Support 4 relay devices (Relay: 1A @ 125V AC/30V DC) |
| (11) CH1~ 16 | Input the video camera signal and display it on channel 1~ 16 |
| (12) 19V DC connector | Connect the power cord into this port |

1.3.3 EXR5008/EXR5016 series

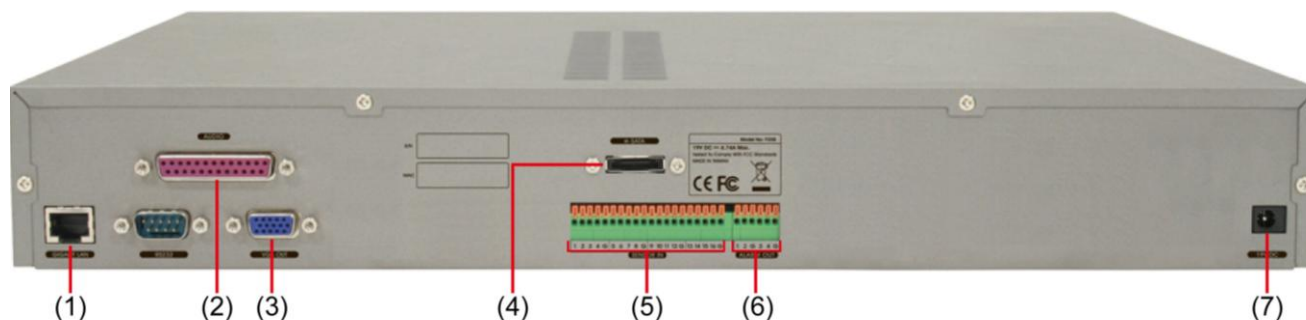



| Name | Function |
|----------------------|--|
| (1) LAN Port | For Gigabit Ethernet connection |
| (2) Audio Out/MIC In | Output and input the audio signal to audio output and input device |
| i | The audio input and output device has its own power supply is necessary. |
| (3) VGA Out | Output the video signal to a CRT or LCD monitor |
| (4) eSATA port | For connecting with eSATA RAID |
| (5) Sensor In | Support up to 16 sensor devices |
| (6) Relay Out | Support 4 relay devices (Relay: 1A @ 125V AC/30V DC) |
| (7) 19V DC connector | Connect the power cord into this port |

1.4 Setting Up the DVR Unit

1.4.1 Installing the Hard Disks

-  For hard disk spec, please referring to <http://www.avermedia.com/AVerDiGi/Product/> → Embedded Hybrid DVR/NVR → AVerDiGi EH5108 series / EH5216 series/EH5108H series/EH5216H series or Pure NVR → AVerDiGi EXR5016 series → Hardware Recommendations
- The external USB hard disk only supports on file backup. Please **do not** install the external USB hard disk for recording purpose.

 EXR5008 Lite and EXR5016 Lite **MUST** purchase **90W adaptor** to support the power supply for 3rd and 4th hard disk.

 The “compatible hard disks” indicated in the above recommendation list only means that these commercially available hard disks were tested with AVerMedia[®] products and functioned well under normal operation conditions. AVerMedia[®] does not guarantee or provide warranties, explicitly, implied or statutory with respect to the reliability of the hard disk function or its compatibility. In no event AVerMedia[®] shall be liable for damages, with respect to any business interruption of clients, lost profits, loss of programs or other data on your information handling system or otherwise. This includes direct, indirect, incidental, special, or consequential damages, resulting from the incompatibility caused by the usage of these hard disks, even if AVerMedia[®] has expressly advised about the risk of such damages. The entire risk arising out of the use of any information attached here with is borne by the recipient.

User can install up to 4 SATA hard disks inside the DVR unit if it is necessary.

Follow the illustrated instructions below to install the hard disk:

1. Loosen all screws



2. Push the cover backward and lift



3. Loosen the screws of holder in order to take out the hard disk rack.



4. Loosen all the screws of hard disk plate.

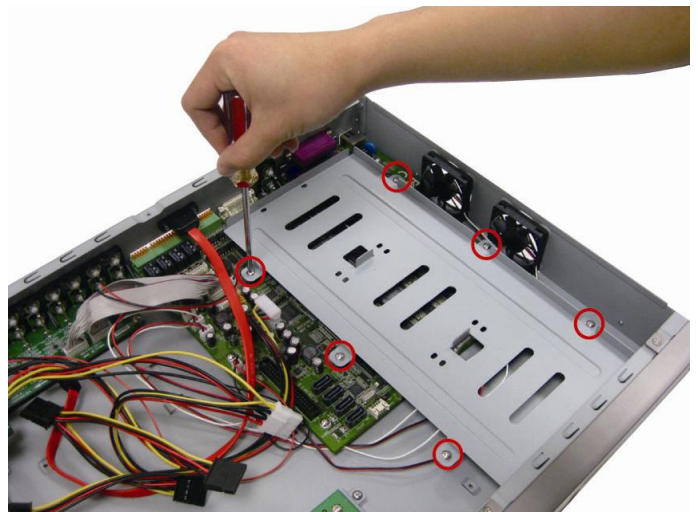

5. The hard disk plate can be installed 3 hard disks. User can choose the position and place the hard disk on it.

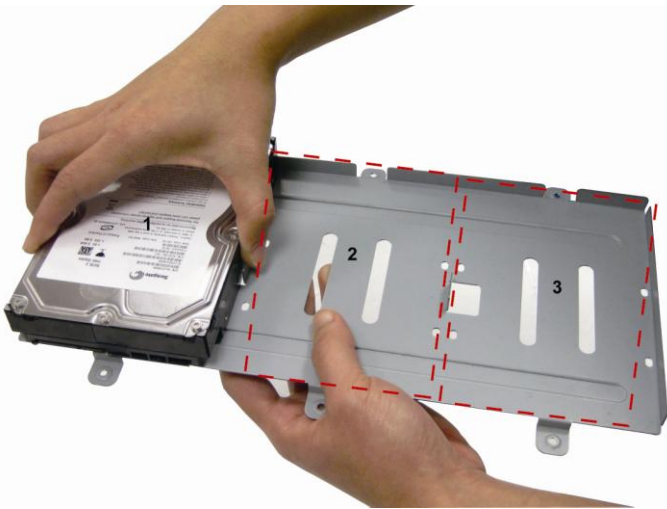

6. Turn the plate and hard disk over carefully and screw the hard disk on the plate. If the hard disk cannot fit into the screw hole, then you may adjust the hard disk position to fit the screw hole.

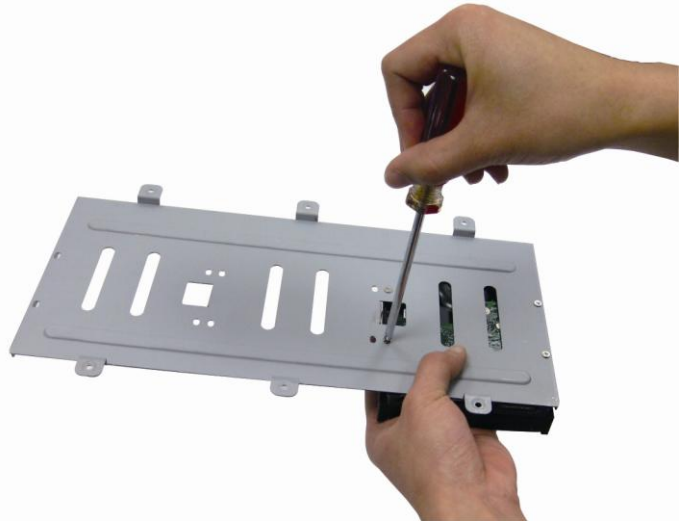

7. The look of three hard disks is installed on the hard disk plate.



8. Plug the SATA cable into the SATA connector on the PC board. If the user installs three hard disks, then plug three SATA cables into each SATA connector on the PC board.

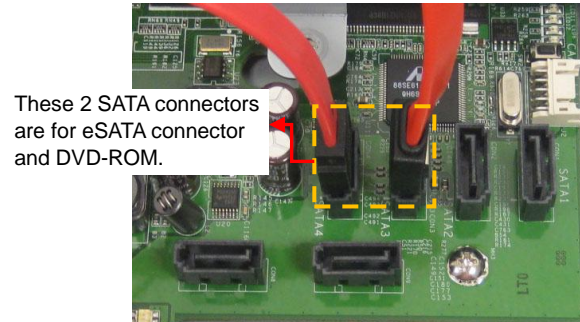

i Some of DVR models may not have a DVD-ROM that depends on the DVR user has purchased.

9. Plug the power cable into the hard disk.



10. Plug the SATA cable into the hard disk. User can unplug the SATA cable of the left side HDD for screwing the plate inside the DVR more easily later.



11. Screw the plate within hard disk inside the DVR unit

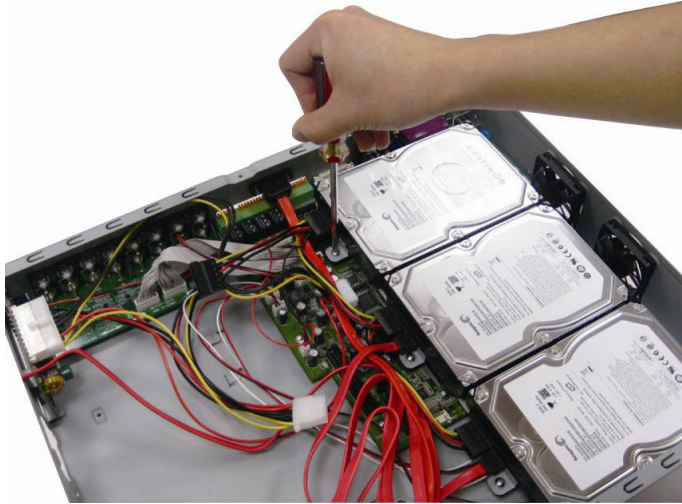

12. Plug the SATA cable into the left side hard disk.



When user remove power cable from hard disk, please **DO NOT** pull the power cable straight way. Please pull out the power cable by moving power connector to left and right side and slowly pull out the power cable from hard disk.

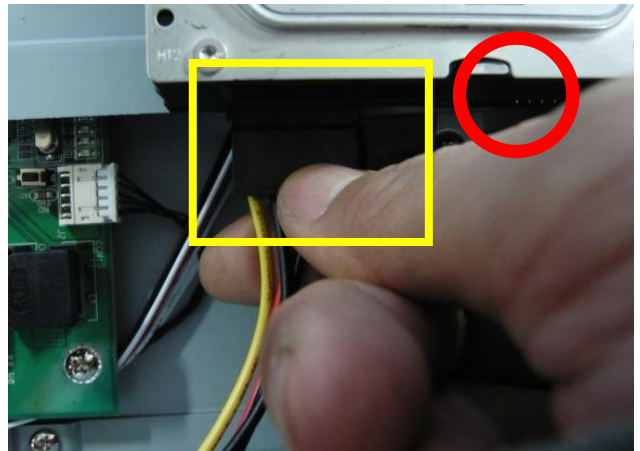
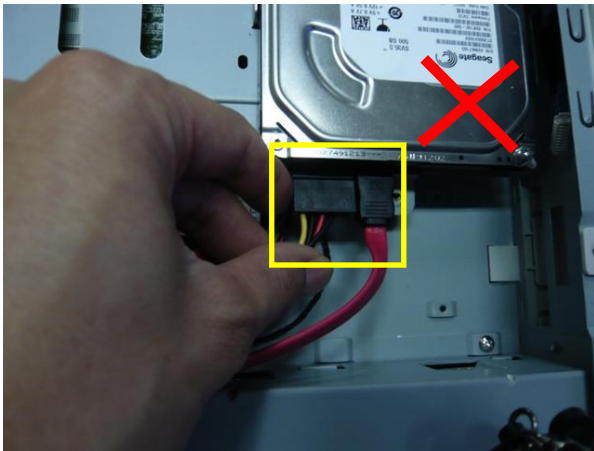

User can adjust the step 9, 10, and 11 for easily install process if necessary.

13. If user wants to install 4th HDD, then follow the steps to continue. Otherwise, go to the last two steps to complete the installation.



EXR5008 Lite and EXR5016 Lite **MUST** purchase **90W adaptor** to support the power supply wattage for 3rd and 4th hard disk.

14. Place the 4th hard disk on the HDD holder. The head side of hard disk is same side of the screw hole of HDD holder.



15. Screwed (6 screws for both side) the hard disk on the HDD holder.



HDD holder is an optional accessory. User need to purchase from your dealer.

16. Plug the SATA cable into SATA connector on the PC board.

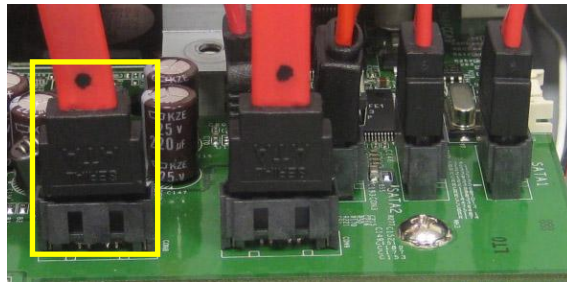
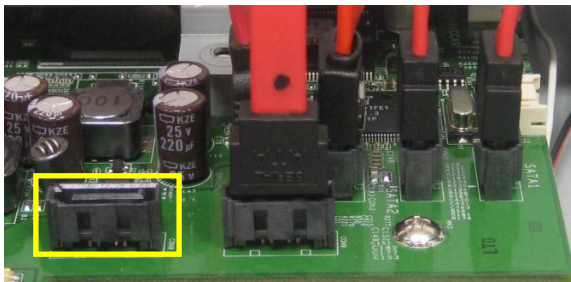

17. Plug the power cable to the hard disk.



18. Plug the SATA cable to the hard disk.



i The SATA cable is an optional accessory. Please purchase from your dealer.

19. Place the HDD holder inside the DVR unit. The screw hole of HDD holder is aligning with screw hole on the DVR unit.



20. Push the HDD holder forward and screw hole of HDD holder will match the screw hole on the DVR unit and HDD holder should hook on the stabled hook on the DVR unit.

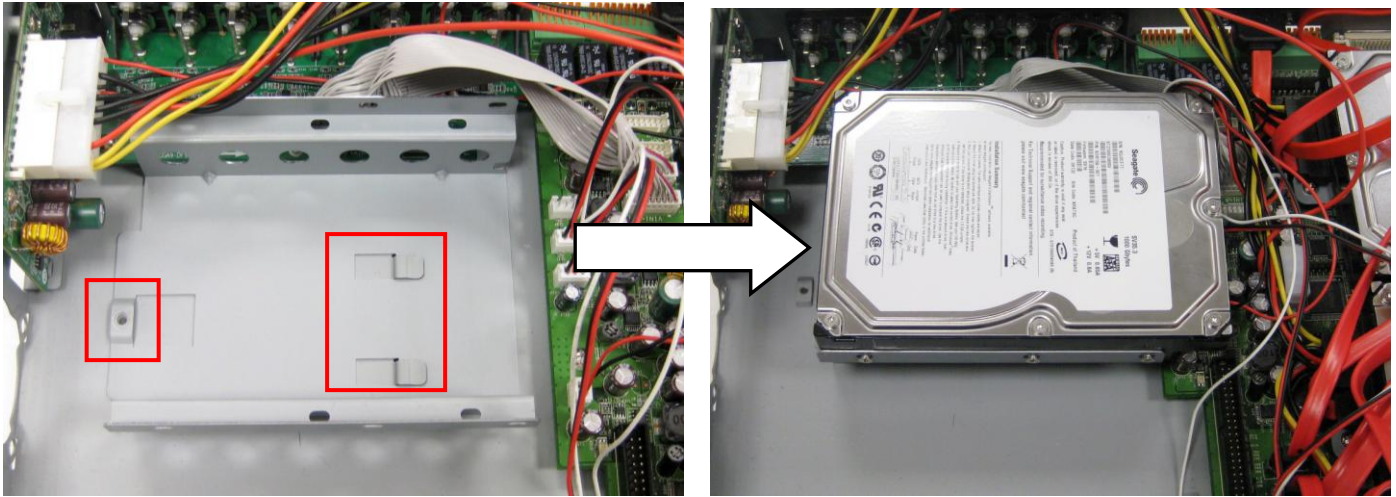

21. Screw the HDD holder inside the DVR unit.



22. Screw the holder on the DVR unit.

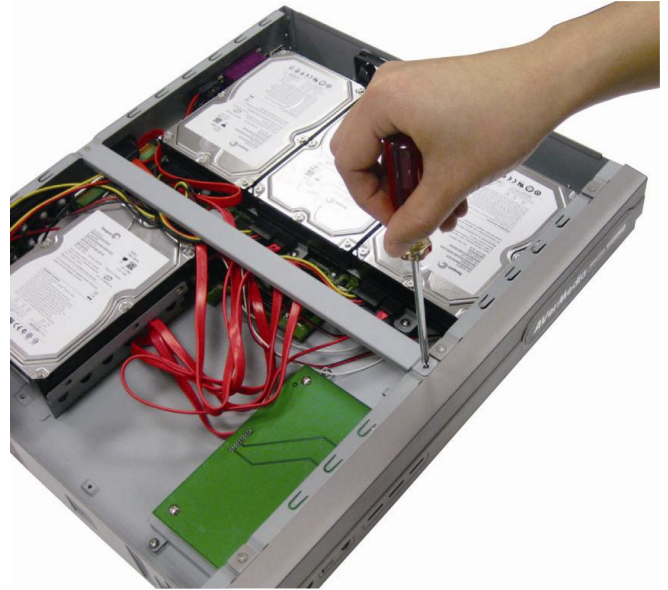

23. The look of four hard disks are installed.



24. Push the cover forward and secure the cover

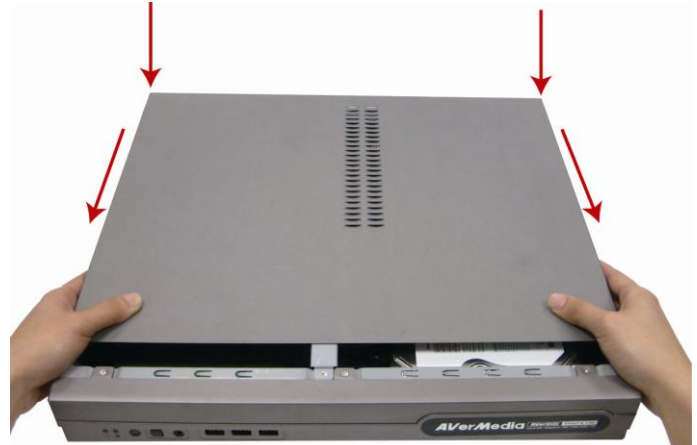

1.4.2 Connecting Devices

1.4.2.1 EH5108 series/EH5108H series

The back panel of the DVR unit, user can connect up to 8 cameras in combination of analog and IP camera. The DVR unit also can connect 16 sensor devices, 4 alarm devices, and output video to a TV or CRT/LCD monitor.

Follow the illustration below to make the connection:

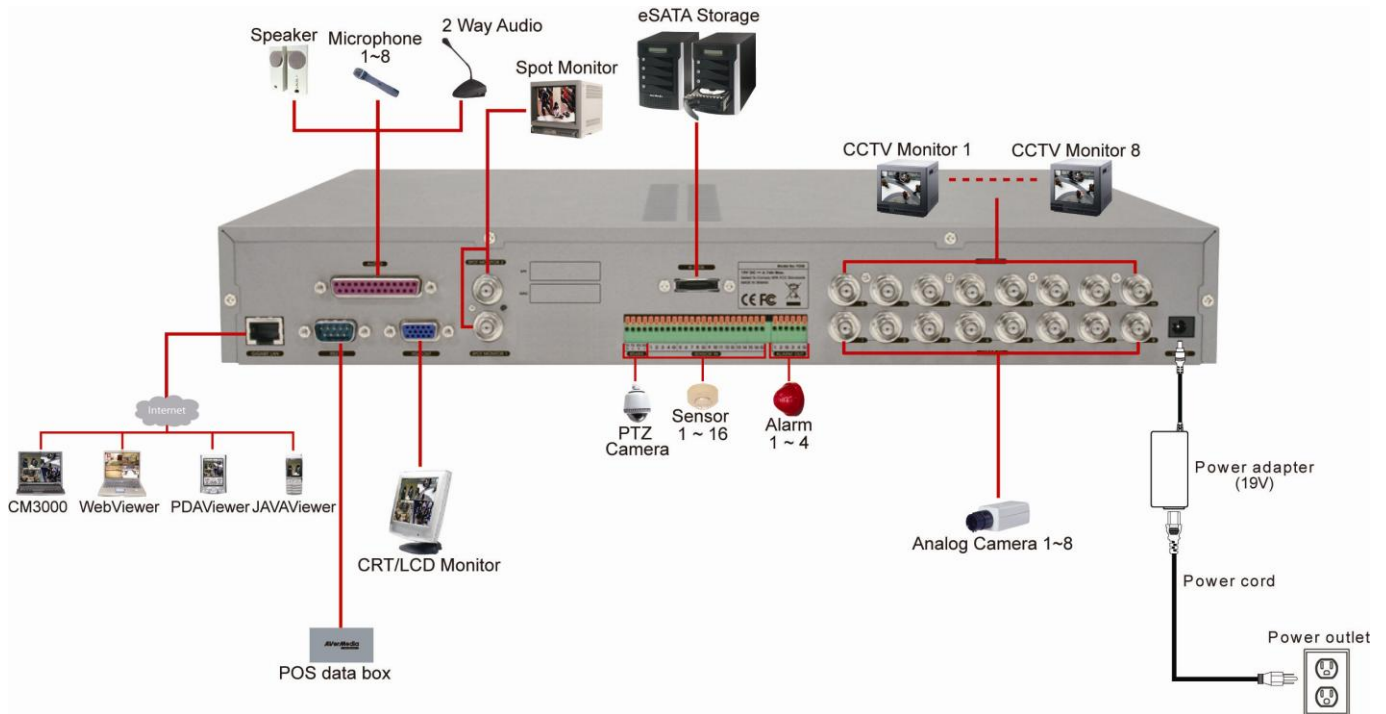

For backup recorded video, plugging the pen drive or external hard disk through USB port that are located at front panel of DVR unit, and then, use the bundled software enables user to transfer, playback and segment the video.

Follow the illustration below to make the connection:

EH5108⁺/EH5108H⁺

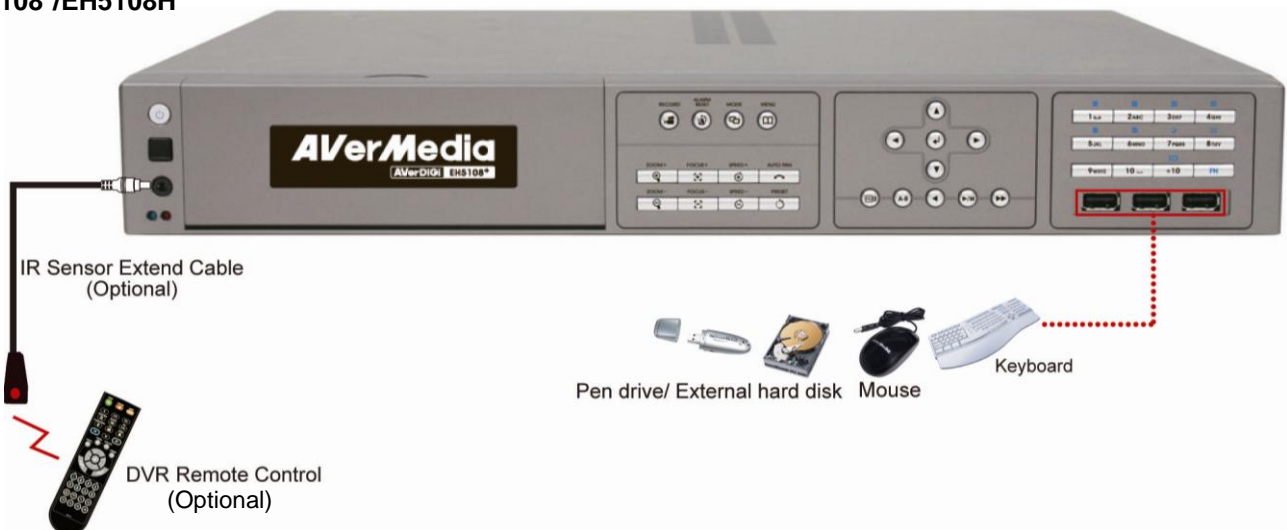

EH5108 Lite/EH5108H Lite



EH5108H



Pen drive and external hard disk must be FAT32 format.



- All connected devices have its own power supply is necessary.
- DVR unit can connect 8 cameras in analog and IP cameras combo.

1.4.2.2 EH5216 series/EH5216H series

The back panel of the DVR unit, user can connect up to 16 cameras in combination of analog and IP camera. The DVR unit also can connect 16 sensor devices, 4 alarm devices, and output video to a TV or CRT/LCD monitor.

Follow the illustration below to make the connection:

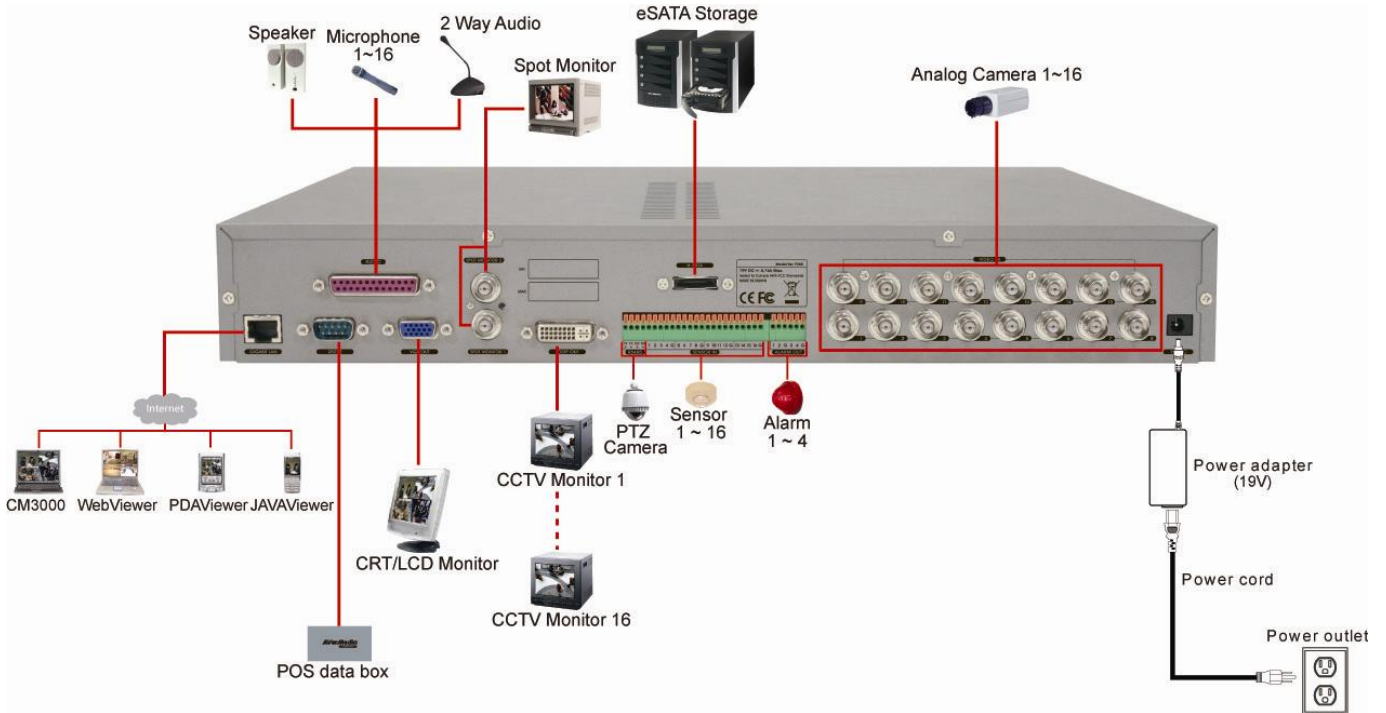

For backup recorded video, plugging the pen drive or external hard disk through USB port that are located at front panel of DVR unit, and then, use the bundled software enables user to transfer, playback and segment the video.

Follow the illustration below to make the connection:

EH5216+ / EH5216H+





EH5216/EH5216H



EH5216 Lite/EH5216H Lite



 Pen drive and external hard disk must be FAT32 format.

-  – All connected devices have its own power supply is necessary.
– DVR unit can connect 16 cameras in analog and IP cameras combo.

1.4.2.3 EXR5016 series

The back panel of the DVR unit, user can connect up to 16 IP cameras. The DVR unit also can connect 16 sensor devices, 4 alarm devices, and output video to a TV or CRT/LCD monitor.

Follow the illustration below to make the connection:

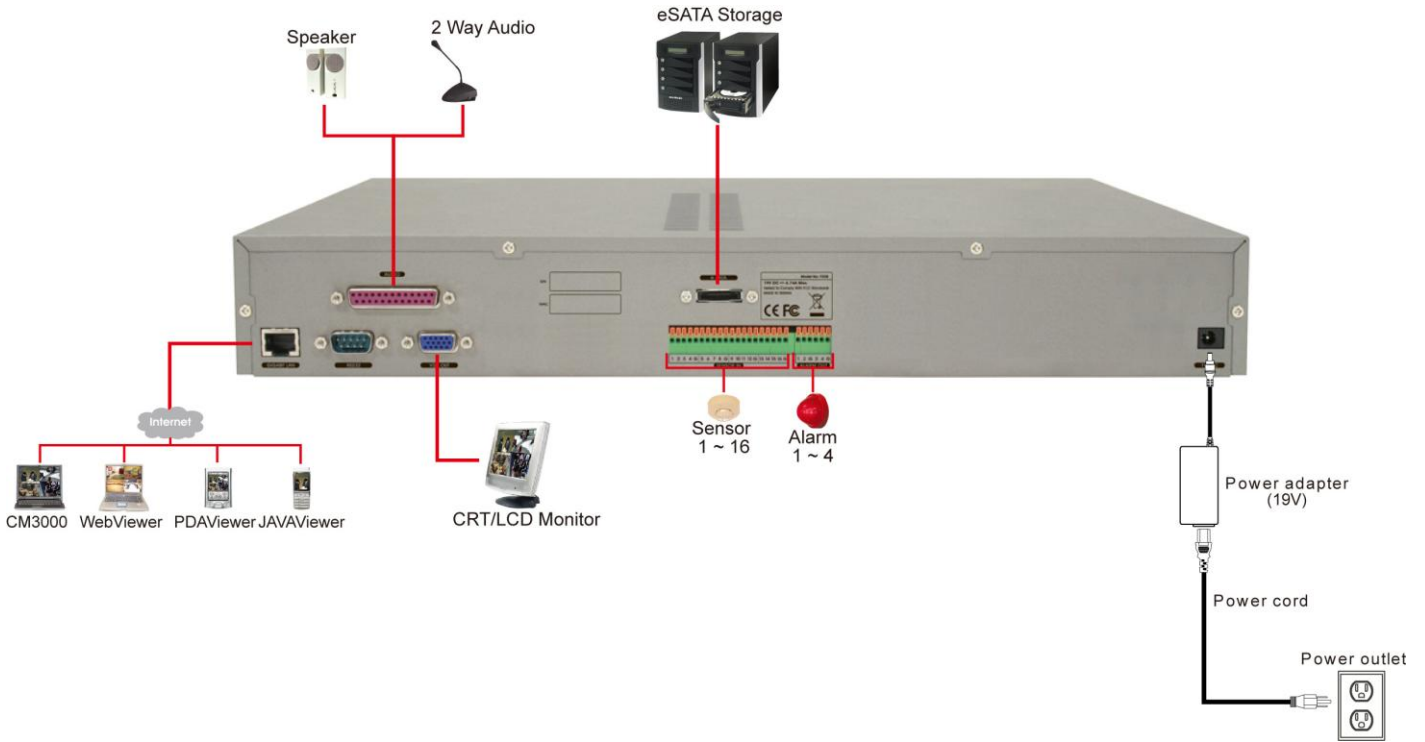

For backup recorded video, plugging the pen drive or external hard disk through USB port that are located at front panel of DVR unit, and then, use the bundled software enables user to transfer, playback and segment the video.

Follow the illustration below to make the connection:





EXR5016

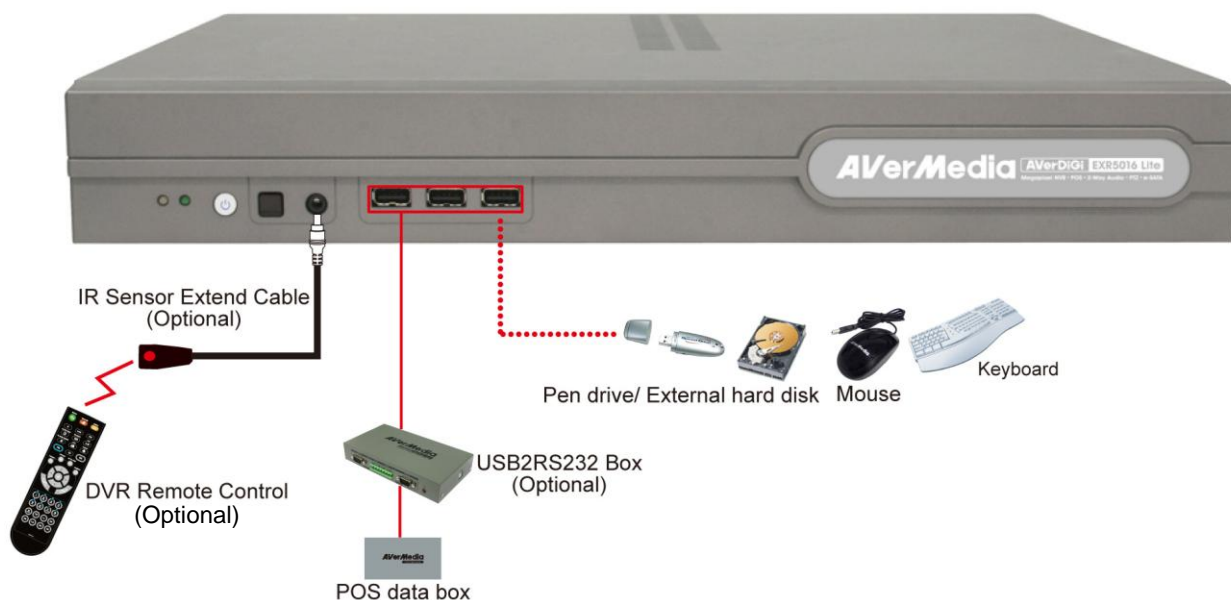

EXR5016 Lite



 Pen drive and external hard disk must be FAT32 format.

-  - All connected devices have its own power supply is necessary.
- DVR unit only can connect 16 IP cameras.

1.5 Sensor, Relay and RS485 pinhole allocation

1.5.1 EH series

The Sensor and Alarm enable you to connect 16 sensor inputs, 4 relay outputs and PTZ cameras. Just connect the external sensor, relay, and PTZ camera pin directly to the pinhole. Check the table below and locate which pinhole is assigned to sensor input and relay output.

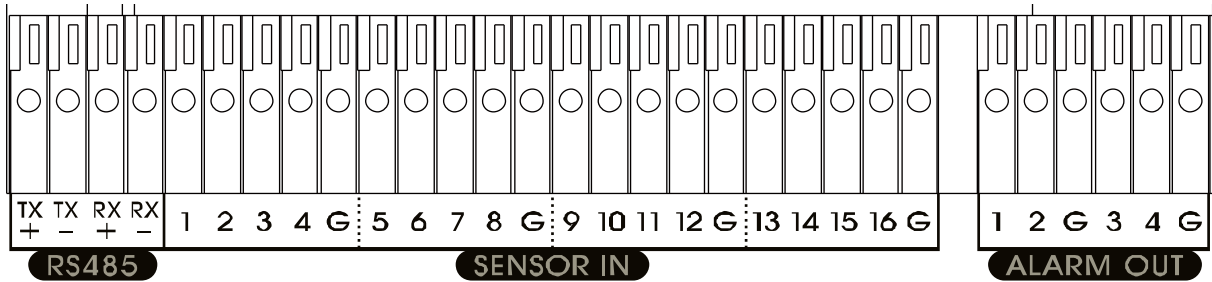

1.5.1.1 Sensor Pin Definition

| Sensor Pin # | Definition | Sensor Pin # | Definition |
|--------------|-----------------|--------------|------------------|
| 1 | Sensor 1 signal | 9 | Sensor 9 signal |
| 2 | Sensor 2 signal | 10 | Sensor 10 signal |
| 3 | Sensor 3 signal | 11 | Sensor 11 signal |
| 4 | Sensor 4 signal | 12 | Sensor 12 signal |
| G | Sensor ground | G | Sensor ground |
| 5 | Sensor 5 signal | 13 | Sensor 13 signal |
| 6 | Sensor 6 signal | 14 | Sensor 14 signal |
| 7 | Sensor 7 signal | 15 | Sensor 15 signal |
| 8 | Sensor 8 signal | 16 | Sensor 16 signal |
| G | Sensor ground | G | Sensor ground |

1.5.1.2 Relay Pin Definition

| Relay Pin # | Definition |
|-------------|--------------|
| 1 | Relay signal |
| 2 | Relay signal |
| G | Relay ground |
| 3 | Relay signal |
| 4 | Relay signal |
| G | Relay ground |

1.5.1.3 RS485 Pin Definition

When connect PTZ camera through RS485 interface, please refer to the following pin definition to connect the DVR and PTZ.

| Pin # | DVR site | PTZ site |
|-------|------------------|------------------|
| TX+ | RS485 TX+ signal | RS485 RX+ signal |
| TX- | RS485 TX- signal | RS485 RX- signal |
| RX+ | RS485 RX+ signal | RS485 TX+ signal |
| RX- | RS485 RX- signal | RS485 TX- signal |

i If user uses the 2 wires for the PTZ camera connection, please connect to the RS-485 TX+ and TX- of the DVR site.

1.5.2 EXR series

The Sensor and Alarm enable you to connect 16 sensor inputs and 4 relay outputs. Just connect the external sensor and relay pin directly to the pinhole. Check the table below and locate which pinhole is assigned to sensor input and relay output.

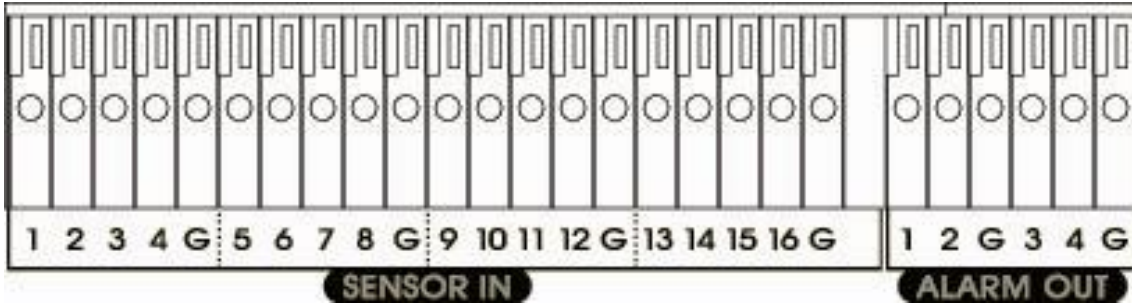

1.5.2.1 Sensor Pin Definition

| Sensor Pin # | Definition | Sensor Pin # | Definition |
|--------------|-----------------|--------------|------------------|
| 1 | Sensor 1 signal | 9 | Sensor 9 signal |
| 2 | Sensor 2 signal | 10 | Sensor 10 signal |
| 3 | Sensor 3 signal | 11 | Sensor 11 signal |
| 4 | Sensor 4 signal | 12 | Sensor 12 signal |
| G | Sensor ground | G | Sensor ground |
| 5 | Sensor 5 signal | 13 | Sensor 13 signal |
| 6 | Sensor 6 signal | 14 | Sensor 14 signal |
| 7 | Sensor 7 signal | 15 | Sensor 15 signal |
| 8 | Sensor 8 signal | 16 | Sensor 16 signal |
| G | Sensor ground | G | Sensor ground |

1.5.2.2 Relay Pin Definition

| Relay Pin # | Definition |
|-------------|--------------|
| 1 | Relay signal |
| 2 | Relay signal |
| G | Relay ground |
| 3 | Relay signal |
| 4 | Relay signal |
| G | Relay ground |

1.6 Familiarizing the Remote Control Buttons

Use the Remote control to operate the DVR unit.

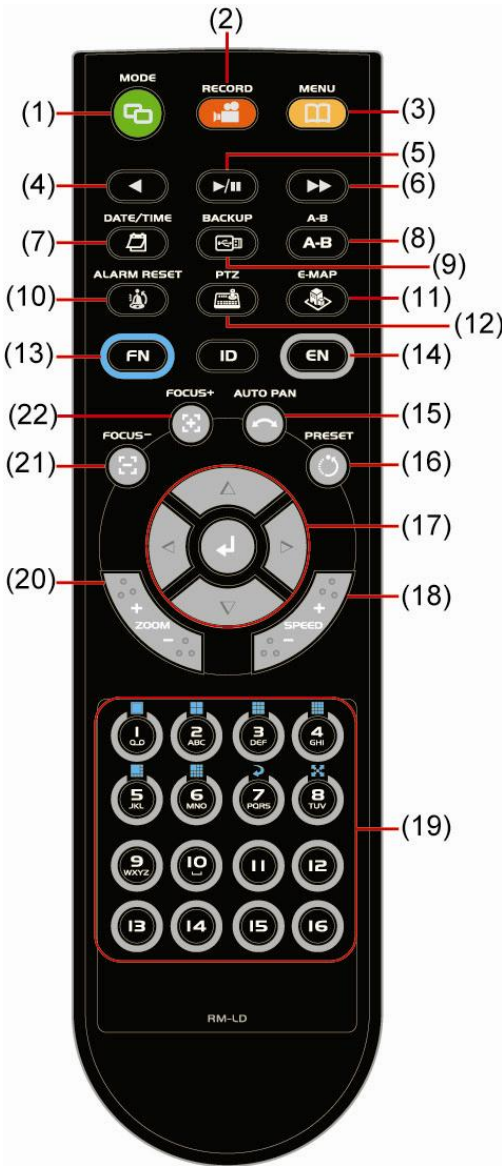

| Name | Function |
|------|---|
| (1) | Switch to playback mode |
| (2) | Start recording video |
| (3) | To call out system setup menu |
| (4) | To rewind the recorded video |
| (5) | To start playback To pause playback |
| (6) | To playback video at faster speed |
| (7) | To select the time and date of playback file |
| (8) | Set a playing recorded video from A point to B point segment and repeat playing on surveillance screen |
| (9) | To backup recorded video file to USB storage device (pen drive or external hard disk) and DVD-ROM. |
| (10) | To reset alarm status |
| (11) | Switch to Emap mode |
| (12) | Switch to PTZ mode. Press + channel number (~) can switch to PTZ control mode if the selected camera is a PTZ camera and the PTZ function is enabled. |

| Name | Function |
|------|----------|
|------|----------|

A functional key for multiple system control

- Press **FN** to enable FN modes (The word "FN" will show up in the left bottom corner on screen).
- To exit FN modes, press **FN** again (The "X" will show up in the left bottom corner on screen).

- (13) **FN**
- FN** + : Switch to single screen display mode
 - FN** + : Switch to QUAD display mode
 - FN** + : Switch to 9 split screen display mode
 - FN** + : Switch to 16 split screen display mode
 - FN** + : Switch to one single and 7 + 1 split screen display mode
 - FN** + : Switch to one single and 12 + 1 split screen display mode

| Name | Function |
|------|----------|
|------|----------|

(13) **FN** +  : Enable/disable auto scan

FN +  : Switch to full screen

 **FN** +  ~  doesn't have any functions.

- Switch to character mode.
- Press **EN** to enter EN mode (The word "EN" will show up in the left bottom corner on screen). User can press the character button and press rapidly to find the character that wants to enter. Press **EN** button again to exit EN mode (The "X" will show up in the left bottom corner on screen).

(14) **EN**

 : backward/delete button

 : abcABC

 : defDEF

 : ghiGHI

 : jklJKL

 : mnoMNO



 : pqrsPQRS



 : tuvTUV

 : wxyzWXYZ

 : space button

(15)  To enable auto pan function

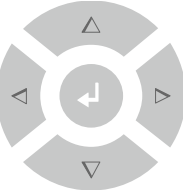
(16)  To move the PTZ camera to the preset position. Press  + number button.











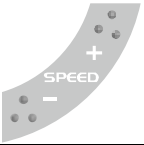



(17)   To move PTZ camera to left



 To move PTZ camera to right

(17)   To move PTZ camera to up

 To move PTZ camera to down

 Confirm or make a selection

| Name | Function |
|--|---|
| (18)  | <p>Speed + : To speed up movement of PTZ camera lens</p> <hr/> <p>Speed - :To speed down movement of PTZ camera lens</p> |
| (19)  | <p> ~ </p> <ul style="list-style-type: none"> - As a number key for entering password in playback and preview mode - Channel camera selection number in playback and preview mode <hr/> <p> +  ~ </p> <p>As a preset position with  at PTZ control mode</p> <hr/> <p> +  ~ </p> <p>With  button can switch to different screen display modes and enable auto scan and full screen. (see also Chapter 1.7 #(16))</p> |
| (20)  | <p>Zoom + : To zoom in view of PTZ camera</p> <hr/> <p>Zoom - :To zoom out view of PTZ camera</p> |
| (21)  | To focus out PTZ camera lens |
| (22)  | To focus in PTZ camera lens |

 The  button doesn't support at this version.

2.1 The Way to Operate DVR

There are three ways can be managed the DVR unit:

1. Using mouse and keyboard

Connecting the mouse and keyboard through USB interface, user can manage the DVR unit easily. For the first time using DVR unit, mouse and keyboard is the best way to set up all DVR relevant configurations.

2. Using Remote Control(Optional accessory)

After DVR unit has been setup, user can use remote control to preview, playback, backup, reset alarm, output video and so on functions.

3. Using Front Panel button(EH5108+/EH5108H+/EH5216+/ EH5216H+/EXR5016+only)

It's an optional way to operate DVR unit. Front panel button function acts as same as remote control.



For the first time using DVR unit, using mouse and keyboard to setup all configurations.

2.1.1 First Time Using the DVR Unit

1. Connect the mouse and keyboard to DVR unit(through USB interface)
2. Power on the DVR unit.
3. For security purpose, the DVR system would require you to enter User ID and Password before it can be accessed. (If this is the first time, enter the default ID [**superuser**] and password [**111111**]).



EH5216EH5216H series UI

4. The hard disk must be formatted before user can use it with DVR unit. Following the below steps to format the hard disk.



- Before formatting hard disk, please stop all operations on DVR system.
- While formatting hard disk, the CPU usage will be near to 100% and might slow down the DVR system response.

- a. Click **Setup** and enter the password
- b. Click **System** → **Add**
- c. Select the hard disk from device list and select **Format type**
- d. Click **Format** button to start formatting

- e. When formatting is done, click **OK**.
5. Setup the date and time in order to have correct recording time and date. Following the below steps to setup date and time:
 - a. Click **Setup** and enter the password
 - b. In **Time** section, click **Setting** button of **System Time**.
 - c. Select the date and adjust the time, and then, click **OK**.
6. Following the below steps to connect the IP and analog camera.
 - **To connect analog camera(For EH series only)**
 - a. Plug the analog camera video cable into DVR video port.
 - b. Click **Setup** → **Camera**
 - c. Select camera channel and type of camera – Analog Camera
 - d. And then, enable the camera
 - e. Give a name of camera and enter short description.
 - f. Adjust the bright, contrast, hue, and saturation of camera
 - g. Click **OK**
 - **To connect IP camera**
 - a. Click **Setup** → **Camera**
 - b. Select camera channel and type of camera – IP Camera
 - c. And then, enable the camera
 - d. Click **IP Setting**
 - e. Enable **Protocol**, and then, select **protocol, mode, video format**, and **channel** of IP camera.
 - f. Enter **IP address** or **URL** of IP camera.
 - g. Enter **ID** and **password** if IP camera's access authority is required.
 - h. Click **OK**.
 - i. To connect another IP camera, follow the above steps.



DVR unit doesn't supply the power to connected external devices.

2.1.2 Using the Virtual Keyboard

User can use the Virtual Keyboard when the keyboard is not available. Just click  or right-click screen to call out the virtual keyboard. For uppercase, click **Caps** button. To exit, click **Esc**.



2.2 Familiarizing the Buttons in Preview Mode

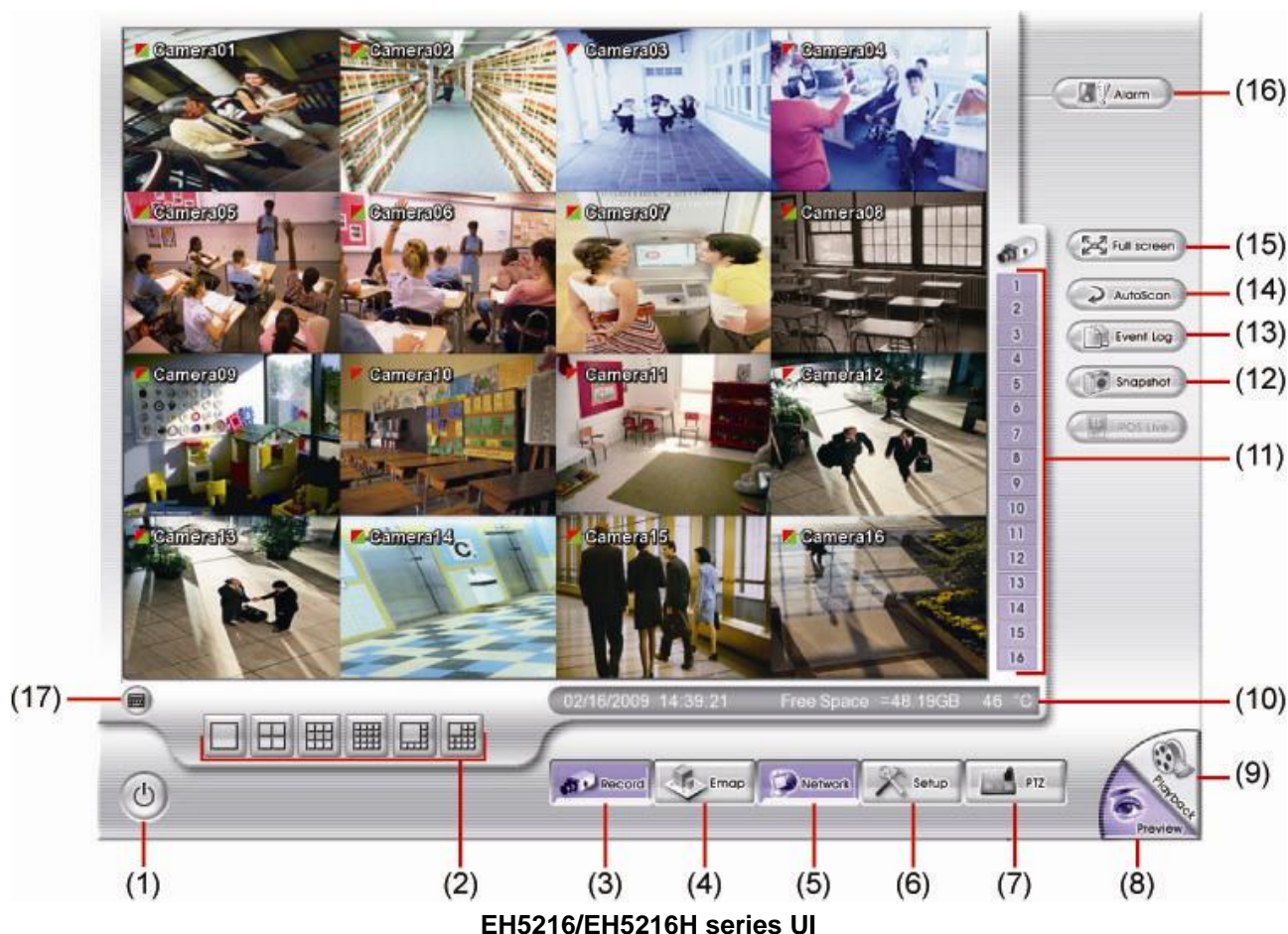

EH5216/EH5216H series UI

| Name | Function |
|-----------------------|---|
| (1) Exit | <ul style="list-style-type: none"> - Reboot: To restart the DVR system. It is required to enter the password - Power Off: To shut down the DVR system. It is required to enter the password - Login: Using different ID to login to DVR system. - Cancel: To return to DVR application. |
| (2) Split Screen Mode | Select from 6 different split screen types to view all the camera, or one camera over the other or alongside on a single screen. It also allows you to switch and view different camera number. |
| i | <ul style="list-style-type: none"> - When you are in single screen mode, Right click and Drag a square on the area you want to enlarge. - When you are in full screen mode, partial enlarges does not support. - If there are only 8 cameras, you won't be able to switch to 13 and 16 split screen mode. |
| (3) Record | Start/stop video recording. |
| (4) EMap | Display the map in each area, and the location of camera/ sensor/ relay and the warning (see also Chapter 2.2.1). |
| (5) Network | Enable/disable remote system access. This feature allows you to access DVR server from a remote location via internet connection. The default is disabled. |
| (6) Setup | Configure the system settings. (see also Chapter 3) |
| (7) PTZ | Access PTZ control panel. (see also Chapter 2.2.2) |
| (8) Preview | Switch to Preview mode. This allows you to view live camera display. |
| (9) Playback | Switch to Playback mode. This allows you to view the recorded video file. (see also Chapter 2.3) |
| (10) Status bar | Display the recorded date, time, hard disk space and temperature of unit. |
| (11) Camera ID | Show the number of cameras that are being viewed. When you are in single screen mode, click the camera ID number to switch and view other camera. |

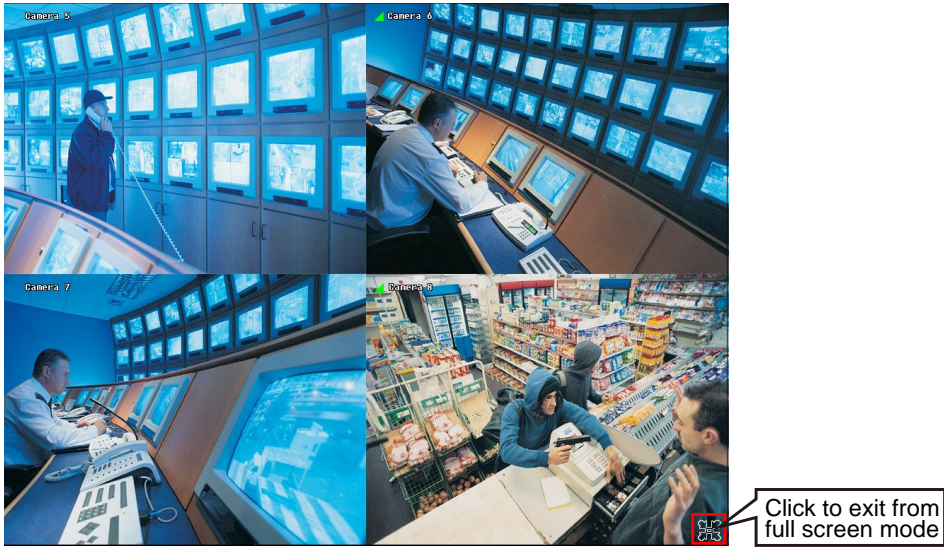
| Name | Function |
|---|--|
| (12) Snapshot | Capture and save the screen shot in *.jpg format. |
|  Please plug the USB pen drive to DVR server before press Snapshot button. | |
| (13) Event log | Show the record of activities that take place in the system. (see also Chapter 2.2.3) |
| (14) AutoScan | Start/Stop video screen cycle switch. |
| (15) Full screen | View in full screen. To return, press the right button of the mouse or ESC on the keyboard or click the arrow icon. |
|  | |
| <p>When you switch to full screen in multiple-screen mode, Left click to toggle to only display one of the video in the multiple-screen mode or all.</p> | |
| (16) Alarm | Alert and display warning info. |
| (17) Virtual Keyboard | Click to enable virtual keyboard. |

2.2.1 Setting Up and Using the Emap

E-Map can hold up to 8 maps in *.jpg format. You may locate the camera, sensor and relay on the map.

To Set Up the Emap

1. Click **Emap**.
2. When the Emap screen appears, click the area number (1 to 8 buttons) on where you want to insert the map.
3. Click **Load Map** to insert the map. When the open dialog box appears, locate and select the map and click **Open**.
4. When the inserted map appears on the Emap screen, click **Edit**. You may now drag the camera, sensor, and relay icons to its place on the map. Icons on the map can be relocated anywhere. If you are going to locate the icon on the map to other area, you need to drag the icon to the black pane at the bottom of the Emap screen and then switch to the area on where you want to locate the icon. To bring all the icons back to the black pane at the bottom of the Emap screen, click **Reset** Icon.
5. When you are done, click **Save** button to save the new setting. To exit Emap screen, click **Close**.

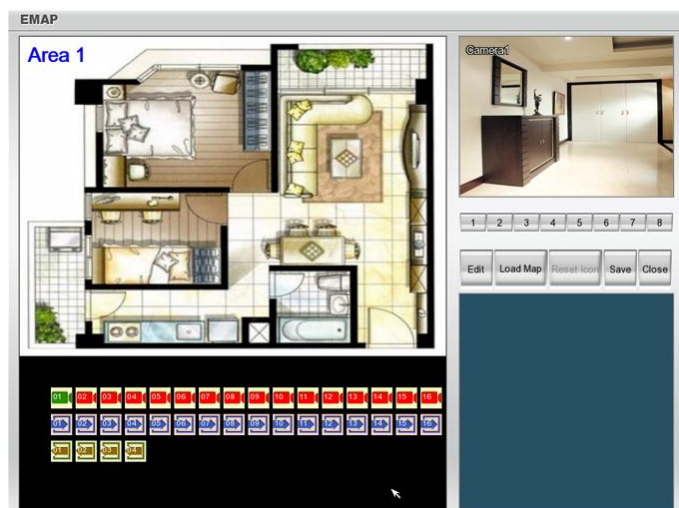

To Use the Emap

1. Click **E-map**.
2. In the Emap screen, click the camera icon to switch on the area where the camera is located on the map

and to display the video at the upper right corner of the Emap screen. At the lower right corner of the Emap screen, it lists all the warning message.

3. Click **Close** to exit Emap screen.

2.2.2 Familiarizing the Buttons in PTZ Camera Controller

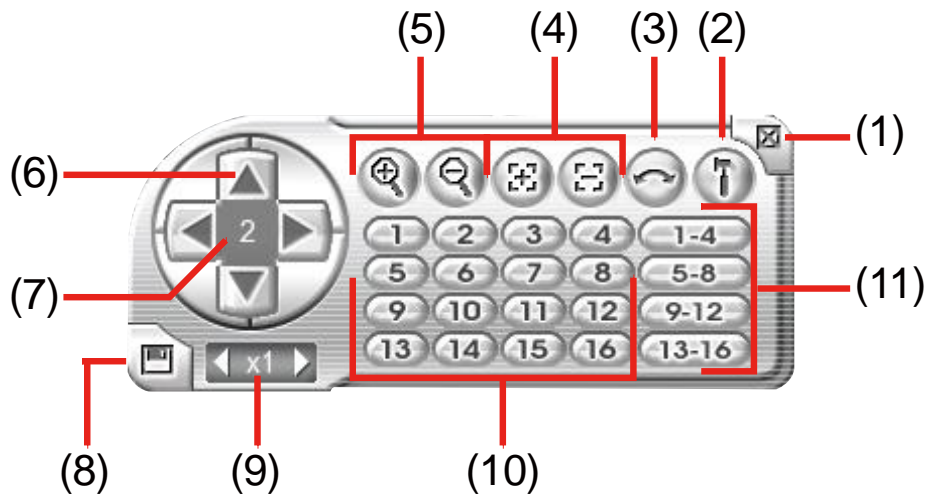

| Name | Function |
|------------------------------------|---|
| (1) Close | Exit PTZ camera controller. |
| (2) Setup | Configure PTZ cameras.(see also Chapter 2.2.2.1 and Chapter 2.2.2.2) |
| (3) AutoPan | Operate the PTZ cameras automatically based on the selected camera group preset position number. |
| (4) Focus +/- | Adjust the focus manually to produce clear image. |
| (5) Zoom +/- | Zoom in and out the image. |
| (6) Direction buttons | Adjust and position the focal point of the PTZ camera. |
| (7) Camera ID pane | Display the PTZ camera number that is being operated. |
| (8) Save Camera preset position | Save the PTZ camera preset position number. Select the camera and click the preset position number and save it. |
| (9) Camera lens speed controller | Adjust the moving speed of the PTZ camera lens. |
| (10) Camera preset position number | Move the PTZ camera to the preset point. |
| (11) Group AutoPan | Select to automatically operate PTZ camera in group. |

2.2.2.1 Setup the Analog PTZ Camera

1. Select the channel of analog PTZ camera on Preview UI.
2. Click **PTZ** button from preview UI.
3. In the PTZ control panel, click **Setup** (see also [Chapter 2.2.2](#)).
4. When the PTZ Setup dialog box appears, select the camera number and check the **Use PTZ** box.

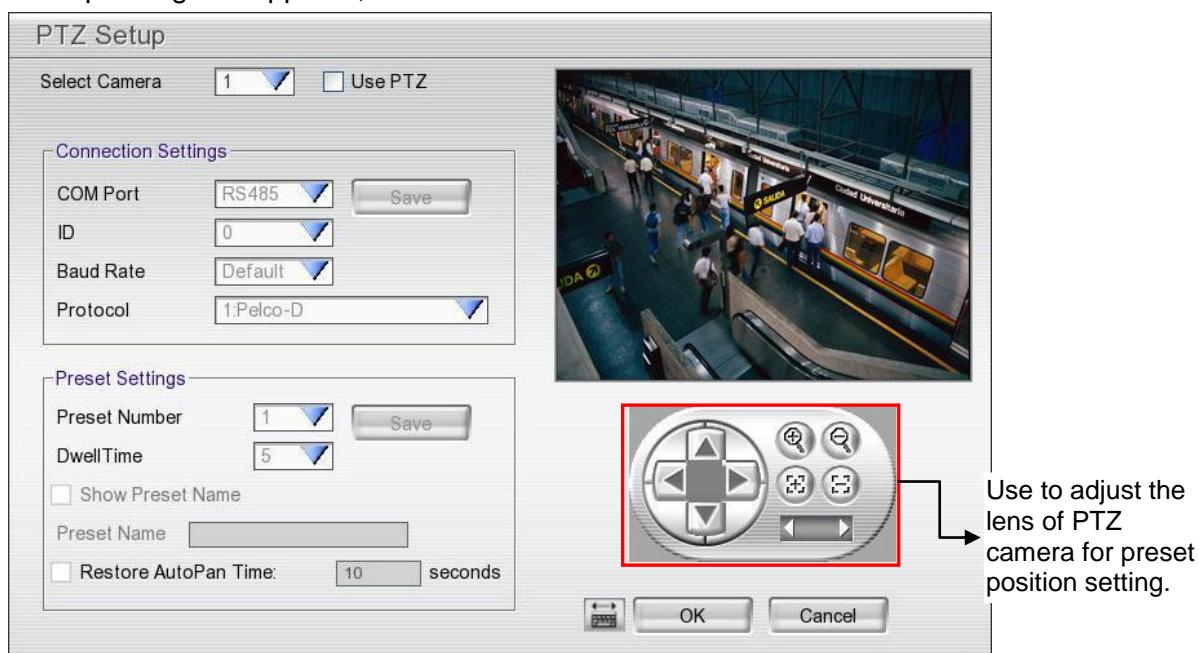

5. In the Connection Settings section, fill in the following selections. Then, click **Save** to keep the settings.
 - **COMPort:** The port that the PTZ camera is connected
 - **ID:** PTZ camera ID number
 - **Baud Rate:** Please refer to the user's manual of the PTZ camera to make sure the baud rate.
 - **Protocol:** Please refer to the user's manual of the PTZ camera to make sure what protocol is using.
6. In the **Preset Setting** section, use the control panel to adjust the position of the PTZ camera and select the preset number to assign a number for the PTZ camera current position. Set the **DwellTime** (1-60 sec) for how long the PTZ camera stays in that position before it moves to the next one. If you want to add description, check the **Show Preset Name** box and in the **Preset Name** text box, type the word. After is done, click **Save** to keep the **Preset Setting** settings.
7. Repeat step 4 and 5, if you want to save another PTZ camera position.
8. **Restore AutoPan Time:** set a time period for restoring auto path function after the PTZ camera has been moved manually. Mark the check box and set the time period in second.
9. After finished all configurations, click **OK** to exit. Click **Cancel** will exit and without saving the settings.

2.2.2.2 Setup the IP PTZ Camera

When IP PTZ camera has successful connected with the DVR system, user can use the PTZ function directly without any configuration. To make connection of IP PTZ camera, please refer to [Chapter 3.2.1](#).

In PTZ camera panel, user can setup the preset position of the camera. The number of preset positions are depend on the IP PTZ camera that user has connected. For example: A brand of IP PTZ camera only supports 4 preset positions. Therefore, user only can setup 4 preset positions on the DVR system. User can refer to the user's manual of the IP PTZ camera to make sure the number of the preset positions has supported.

Please follow the below steps to configure the preset position.

1. On Preview UI, select the channel that is an IP PTZ camera connection.
2. Click **PTZ** button from Preview UI and PTZ control panel will show up.
3. In the PTZ control panel, using the arrow button to adjust the position of IP PTZ camera.
4. And then, click **Setup** (see also [Chapter 2.2.2](#)). The Preset Settings window will show.

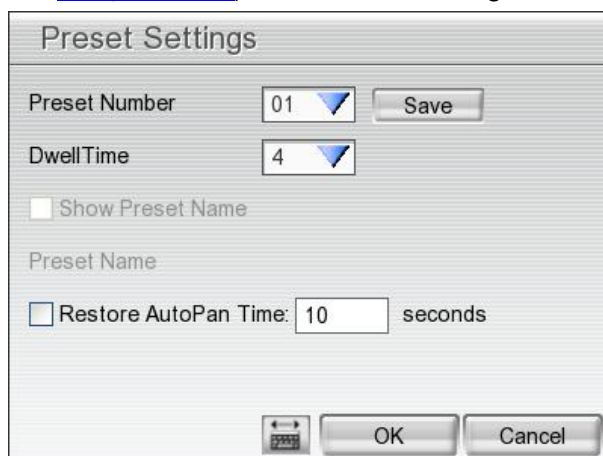

5. Select the **Preset Number** to assign a number for the PTZ camera current position. And then, click **Save** to save the setting.
6. Set the **DwellTime** for how long the PTZ camera stays in that position before it moves to the next one.
7. Repeat step 3 to 6, if you want to save another preset position.
8. **Restore AutoPan Time:** set a time period for restoring auto path function after the PTZ camera has been moved manually. Mark the check box and set the time period in second.
9. Click **OK** to complete the setting.

2.2.3 Using Event Log Viewer

Show the record of activities that take place in the system.

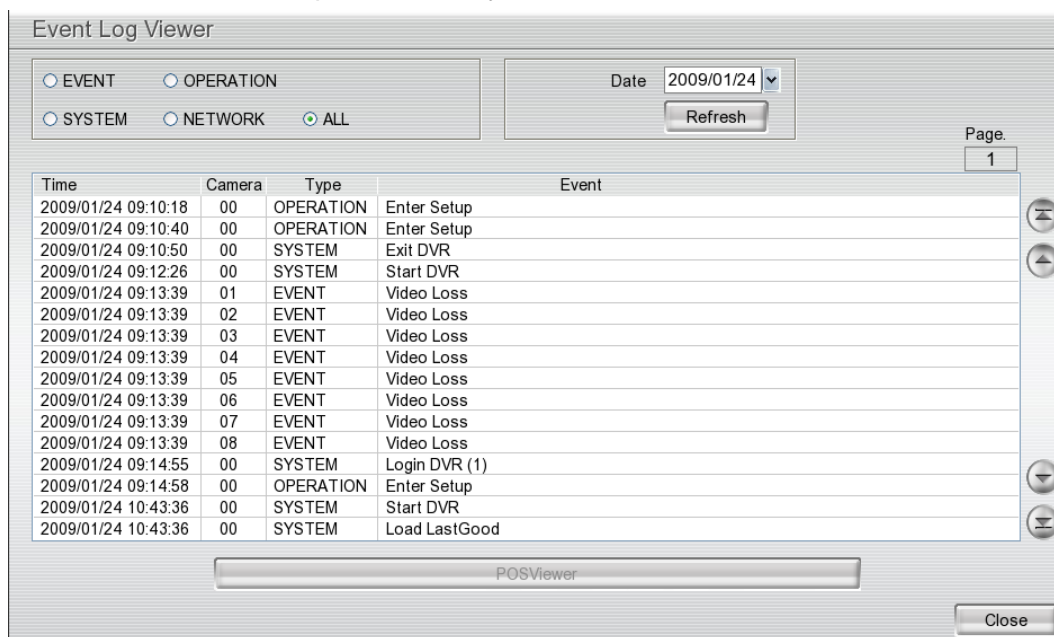

1. Click the **Event Log** button on DVR system main interface. The Event log viewer window will show up.
2. Select the **Date** to view.
3. To filter the records, select and click the select button to display **Event**, **System**, **Operation**, **Network** or **All**.
4. Use the scroll button to go next, previous, first, or last page of event list. Also, user can enter the page number in **Page** column to go to the page.

2.3 Familiarizing the Buttons in Playback Mode

To switch in Playback mode, click **Playback** button at the lower right corner of Preview mode user interface.



EH5216/EH5216H series UI

| Name | Function |
|------------------------------|---|
| (1) Split Screen Mode | Select from 6 different split screen type to playback the recorded video file of all the cameras or one camera over the other or alongside on a single screen. |
| i | <ul style="list-style-type: none"> When you are in single screen mode, Right click and Drag a square on the area you want to enlarge. When you are in full screen mode, partial enlarges does not support. If there are only 8 cameras, you won't be able to switch to 13 and 16 split screen mode. |
| (2) Progress bar | Show the progress of the file being played. You may move the bar to seek at any location of the track. |
| (3) Hour Buttons | Select and click to playback the recorded video file on the specific time frame. |
| i | The Hour buttons represent the time in 24-hour clock. The blue bar on top of the hour button indicates that there is a recorded video file on that period of time. While the red bar indicates that you are currently viewing the recorded video file. |
| (4) Playback Control Buttons | <p>Begin: Move at the beginning of the recorded video file.</p> <p>Previous: Go back to the previous frame.</p> <p>Slower: Play the recorded video file at the speed of 1/2X, 1/4X, 1/8X, 1/16X, or 1/32X.</p> <p>Rewind: Wind back the recorded video file.</p> <p>Pause: Briefly stop playing the recorded video file.</p> <p>Play: Play the recorded video file.</p> <p>Faster: Play the recorded video file at the speed of 2x, 4x, 8x, 16x, 32x, or 64x.</p> <p>Next: Go to the next frame.</p> <p>End: Go to the end of the recorded video file.</p> |
| (5) Date | Select the date on the calendar and the time from 00 to 23 to where to start playing the recorded video file. |
| i | The numbers from 00 to 23 represent the time in 24-hour clock. The numbers from 01 to 16 represent the camera ID. The blue colored column indicates that there is a recorded video file on that period of time. While the red colored column indicates on where to start playing the recorded video file. |

| Name | Function |
|----------------|---|
| (6) Preview | Switch to Preview mode. |
| (7) Playback | Switch to Playback mode. This allows you to view the recorded video file. |
| (8) Status bar | Display the recorded date, time and play speed. |
| (9) Camera ID | Show the number of cameras that are being viewed. When you are in single screen mode, click the camera ID number to switch and view other camera. |
| (10) Export | Export includes Snapshot, Output Video Clip, and Backup function. <ul style="list-style-type: none"> ■ Snapshot: Capture and save the screen shot either in *.jpg format. ■ Output Video Clip: Save the segmented file in *.dvr format to external USB storage device (see also Chapter 2.3.1). |

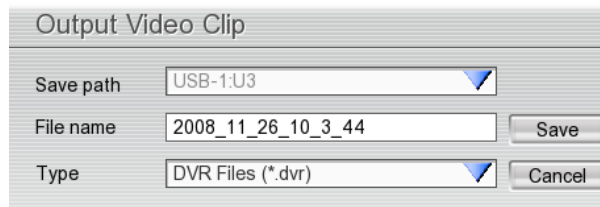

- **Backup:** Save the playback file to USB device or DVD-ROM disk(see also [Chapter 3.6](#))

i Please plug the USB pen drive to DVR server before execute **Export** function (Snapshot, Output Video Clip, and Backup).

| | |
|------------------|--|
| (11) Segment | Keep a portion of the recorded video (see also Chapter 2.3.1). |
| (12) Full screen | View in full screen. To return, press the right button of the mouse or ESC on the keyboard or click the arrow icon. |



When you switch to full screen in multiple-screen mode, **Left** click to toggle to only display one of the video in the multiple-screen mode or all.

| | |
|--------------------|--|
| (13) Event log | Show the record of activities that take place in the system. To filter the records, select and click the option button to only display Event, System, Operation, Network or All. |
| (14) Bookmark | Mark a reference point when reviewing the recorded video file to which you may return for later reference (see also Chapter 2.3.2). |
| (15) Visual Search | Search from a specific camera by Date, Hour, Minute, 10 Seconds and Second(also see Chapter 2.3.3) |
| (16) Find Next | Search for the next event. You can use this when you are using Event Search function. |
| (17) Event Search | Search from the recorded activities that were recorded in event log (i.e., Sensor, Motion, Video Loss). (see also Chapter 2.3.4) |
| (18) De-interlace | To enhance the video quality. Set the de-interlace mode to #1, if you are capturing motionless picture and #2, if it captures lots of movement. |

2.3.1 To Cut and Save the Portion of the Recorded Video

1. Use the Playback Control buttons or drag the bar on the playback progress bar and pause on where you want to start the cut. Then, click **Segment** to set the begin mark.



2. Use the Playback Control buttons or drag the bar on the playback progress bar and pause on where you want to end the cut. Then, click **Segment** to set the end mark. To cancel segmentation, click **Segment** button again.



3. Click **Export > Output Video Clip** button to save the wanted portion.
4. In the **Save As** dialog box, locate on where user wants to save the file, type the filename, and select the video format.

2.3.2 To Bookmark a Video Section

1. Click **Bookmark** button
2. In the Bookmark dialog box, you may do the following:
 - **Add** to create the new reference mark in the bookmark list.
 - **Edit** to change the mark description.
 - **Delete** to remove the selected reference mark in the list.
 - **Delete All** to remove all the reference marks in the list.
 - **Exit** to close Bookmark dialog box.
3. Select and click one in the bookmark list to review the file.

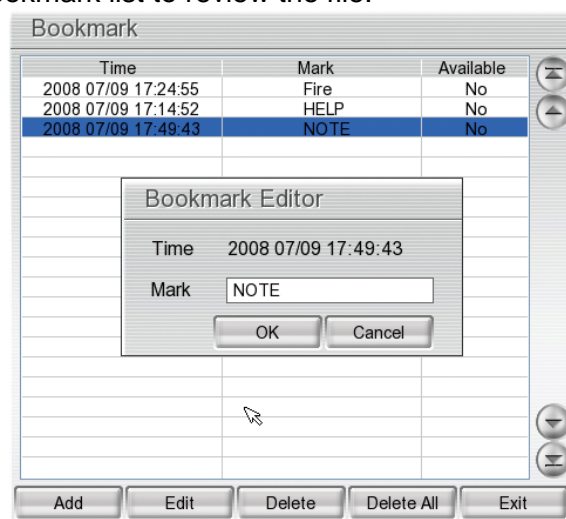

2.3.3 Using Visual Search

1. Click **Visual Search**.
2. In the Visual Search Setting dialog box, select the Camera number and the date. Then click **OK**.

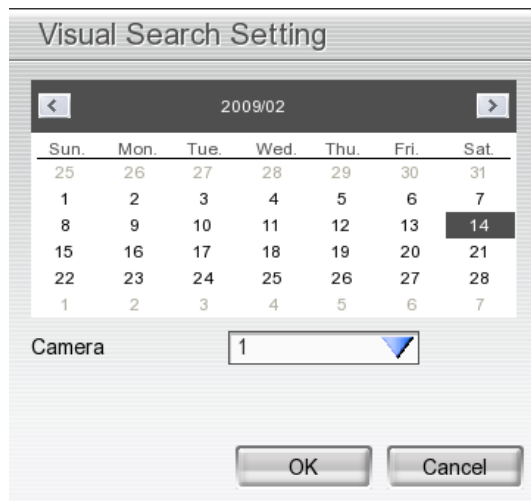

3. When a series of frames appear by date, click on the frame to display another series of frames and search by every Hour of that date, every Minutes of that hour, and every Seconds of that minute. Using and to go next and last page of time page. To go back last time selection (hour, minute, or second), click . To close event search, click . Click to select different date of video for visual search.

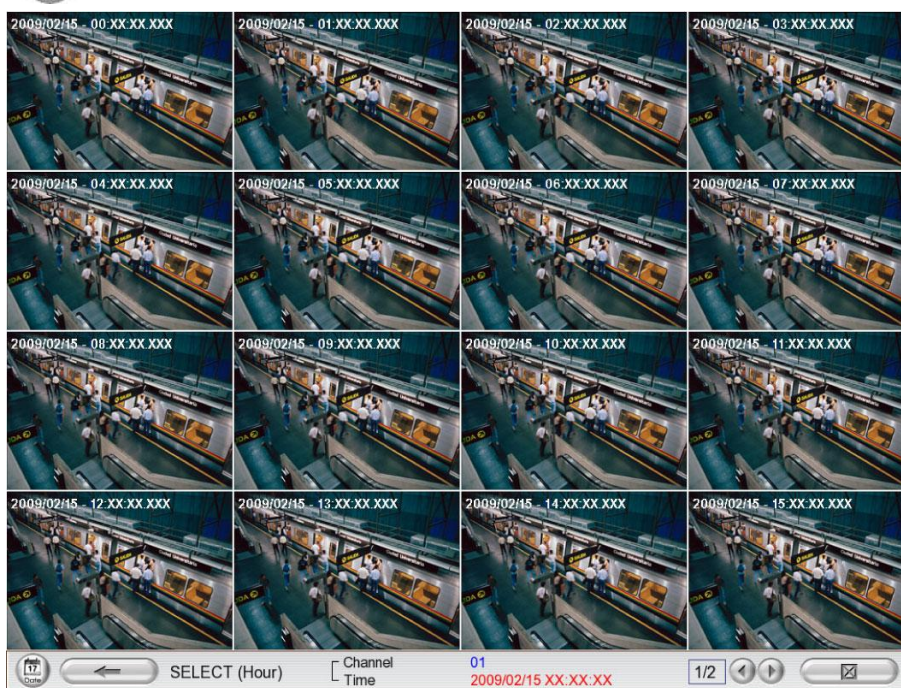

4. On the time second screen, click the channel and playback button will appear. Click playback button to playback the selected channel video frame.



2.3.4 Using the Event Search

1. Click on the video screen on where you want to search.
2. Click **Event Search**. The Event Search Setting dialog box would appear on the screen.
3. In the Event Search Setting dialog box, check the type of condition you want to search. Then, click **OK** to start searching. The video search would stop at the frame that matches the condition. To keep on searching click .
4. You may also set to search and list all the result. In the **Search Duration** section, set the **Begin Time** and **End Time**. Set the **Searching Interval** time that system won't list out the same events in a period of time that user has setup. Then, click **OK** to start searching.

i The DVR system will automatically set the date of **End Time** at 3 days later of **Begin Time**. If event data are less than 3 days, the DVR system will set End Time at current date. Time of End Time is adjustable.

5. When the Event list appear, click and select the item you want to view.

Event Search Setting

Searching Condition

Sensor
 Motion
 Video Loss

Searching Duration

Begin Time: 2008/11/26 P.M.03:46:54
 End Time: 2008/11/26 P.M.03:46:54
 Searching Interval: 3 Seconds



In the Preview screen mode, click  button to customize your DVR. When the DVR configuration setup selection appears, select and click the buttons you want to change the setting.



3.1 System Setup

In the System Setting dialog box, click **OK** to accept the new settings, click **Cancel** to exit without saving.

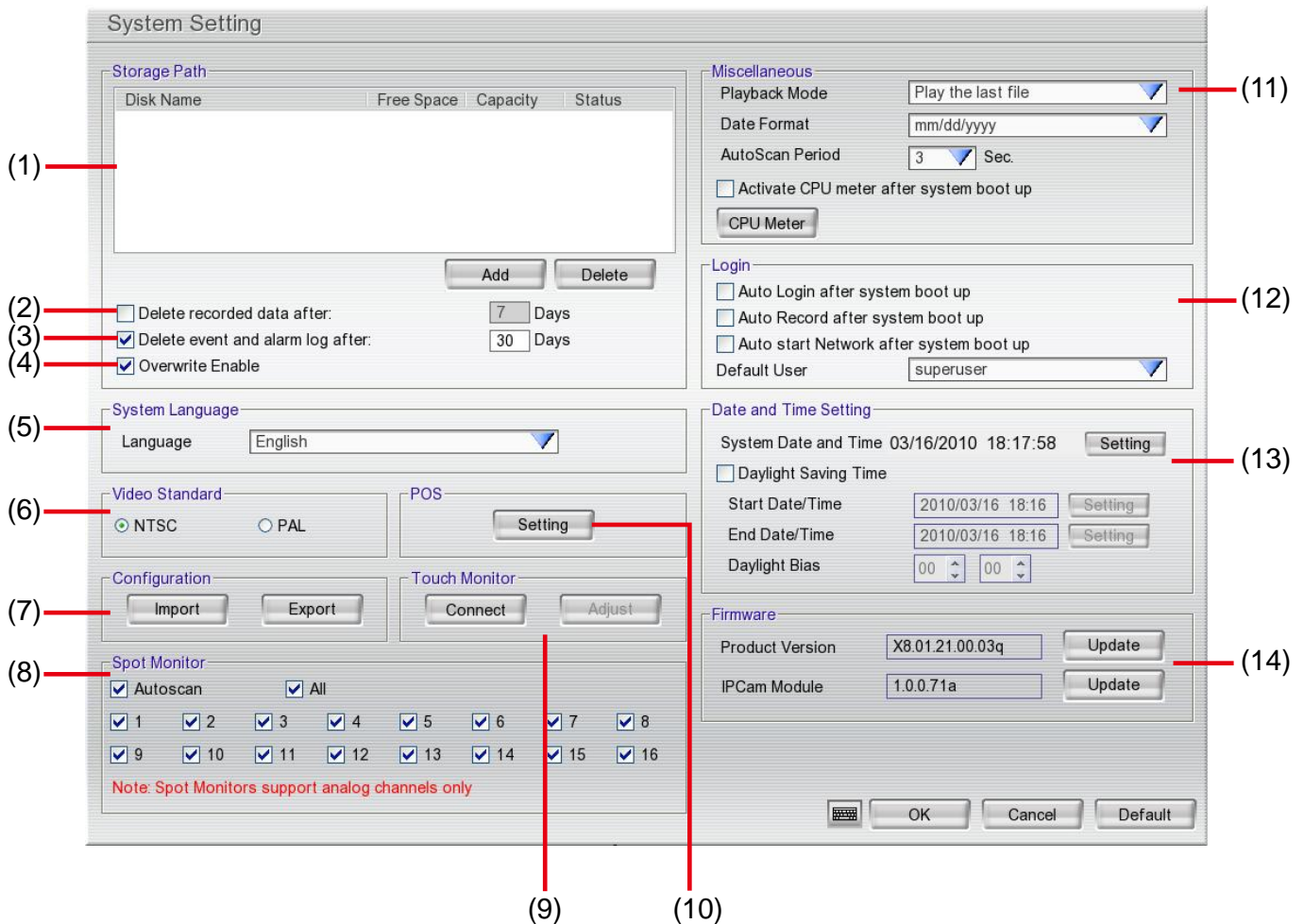

(1) Storage Path

Set the HDD on where to save the data. In case you have more than one storage device, the system automatically saves the data to the next storage device. To insert another storage device, click **Add** and select the storage path. To remove the selected path, click **Delete**. If the hard disk is the first time for DVR system, please format the hard disk before starting to use it. To format the hard disk, select the hard disk and **Format Type**, and then, click **Format** button.

-  - Before formatting hard disk, please stop all operations on DVR system.
- While formatting hard disk, the CPU usage will be near to 100% and might slow down the DVR system response.

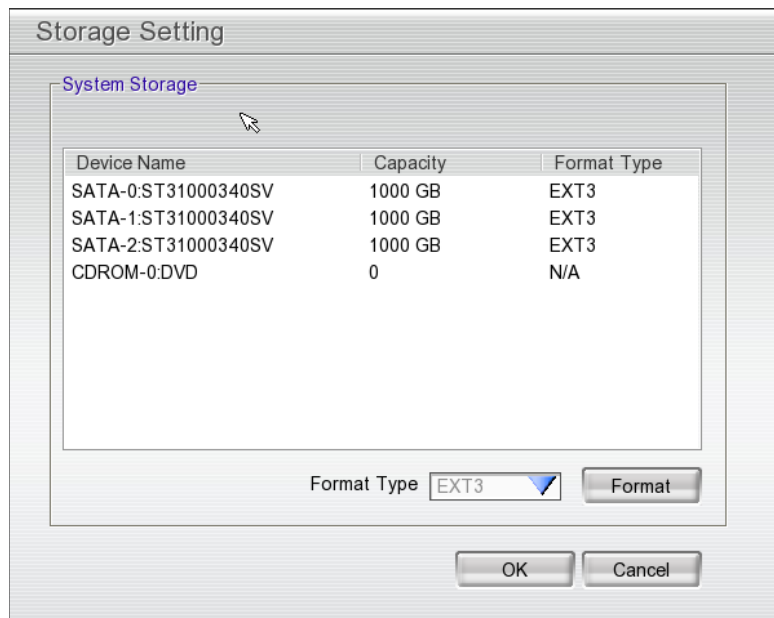

(2) Delete recorded data after

If you want the system to automatically erase the data after a certain days, enable the **Delete recorded data after** check box and enter the number of days in **Days** text box.

(3) Delete event and alarm log after

If you want the system to automatically erase the event and alarm log after a certain days, enable the **Delete event and alarm log after** check box and enter the number of days in **Days** text box.

(4) Overwrite Enable

When there is not enough free space to record one hour data, the system automatically replaces the oldest data.

(5) Language

Customize the system to display the tool tips and dialogs based on the selected language. Default language is in English.

(6) Video Standard

Change and select the proper video system according to your camera video system. If the video system setting is wrong, the video would appear abnormal.

(7) Configuration

Backup a copy of all the settings and allows you to regain the same settings back. To save the current settings, click **Export**. To replace the settings with the one you have saved, click **Import**.

 Please plug the USB pen drive to DVR server before **Import** or **Export** the configuration from or to USB pen drive.

(8) Spot Monitor

Select the camera user wants to display on spot monitor or select **All** for all cameras. Mark **Autoscan** to enable display to take turns automatically.

(9) Touch Monitor

When DVR server is connected with touch monitor, user needs to adjust touch monitor in order to work normally.

1. Connect the touch monitor with DVR server.
2. Turn on the DVR server and touch monitor power.
3. Select **Setup** → **System** → **Touch Monitor** → **Adjust**.
4. The adjusting window will show up.

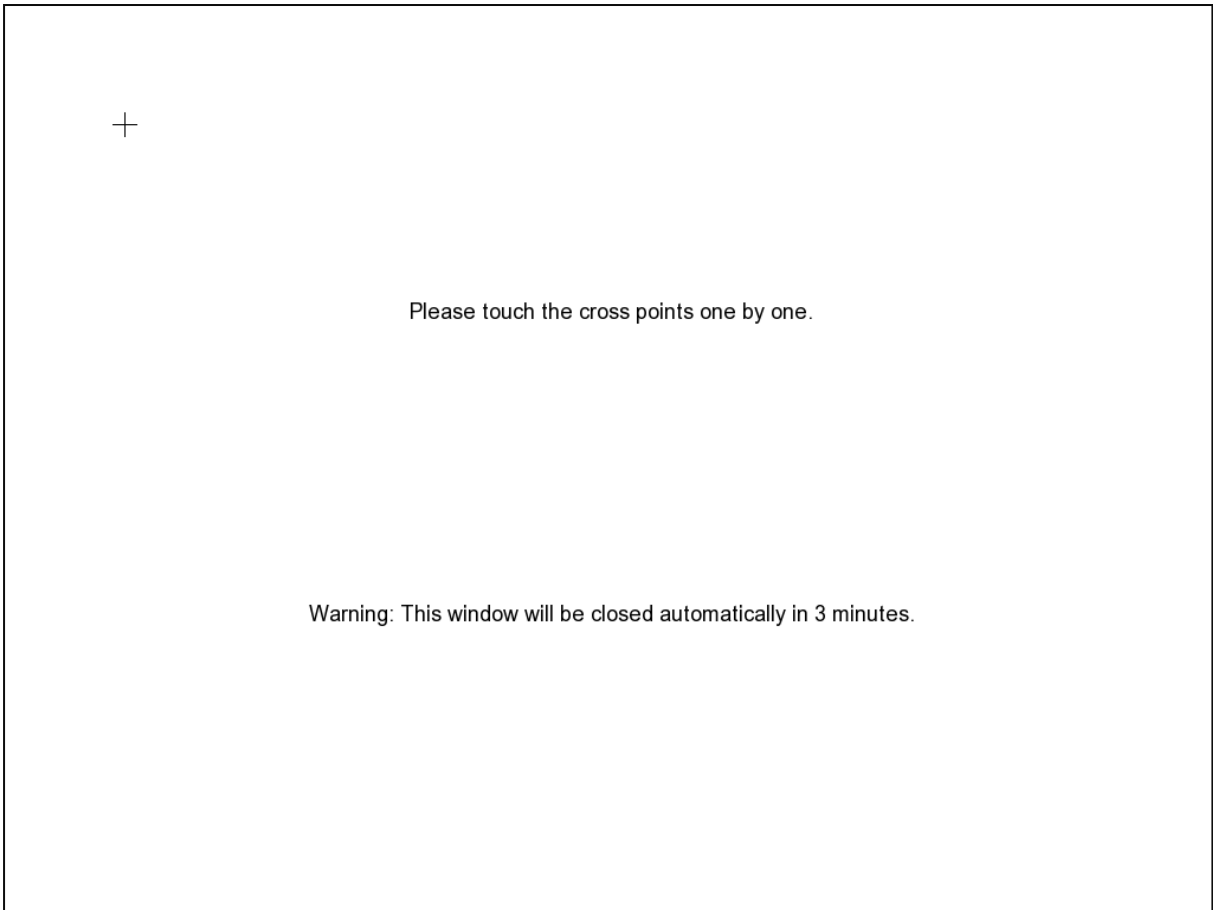

5. Click **+** one by one to complete the adjustment.
6. To disconnect touch monitor, click **Disconnect** button first, and then, turn off the power of touch monitor and remove the connection between DVR server and touch monitor.

(10) POS

Set from which camera screen to display the data from the POS equipment. Click **Setting**, to set the POS Console Setting.

1. In the POS Console Setting dialog box, click **Add** to set a new POS setting, **Modify** to change the POS setting, and **Delete** to remove the selected POS setting. Click **OK** to save and close POS Console Setting.

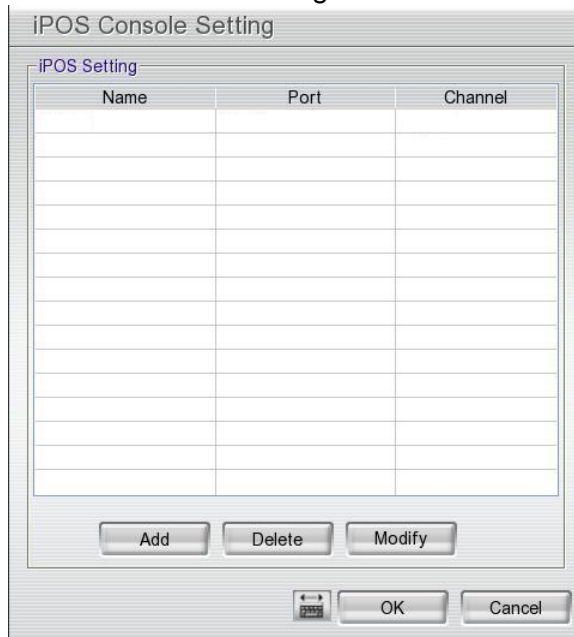

2. In the POS Mapping dialog box, click **OK** to accept the settings and **Cancel** to exit without saving the new setting.

- (1) **Name:** Enter a name to identify the POS.
- (2) **Protocol:** Select the protocol.
- (3) **Skip first:** Set the number of lines you want to be removed.
- (4) **Font Color:** Select the text color of the POS data.
- (5) **Port Setting :** Select the **Local**(Com port) where it is connected and **Baud Rate**.
- (6) **Map to Channel:** Select to which camera number to display the transaction text.



EH5108/EH5108H/EXR5008 series only has 8 channels will be available.

- (7) **Text Filter:** Enter the word you want to be removed.

(11) Miscellaneous

- **Playback mode:** Select the mode of playback the video.
 - **Select date and time:** Select the date and time which user wants to playback.
 - **Play the last file:** Automatically playback the video from the last hour
 - **Instant Playback:** Automatically playback the video which has just recorded
- **Date Format**
Select the date format which wants to display in select date and time playback mode
- **Auto Scan Period**
Set the time gap of the Auto Scan function from 3 to 10 seconds. This automatically switches to the next video in cycle depending on the set time gap.
- **Activate CPU meter after system boot up**
Mark to enable the CUP usage status display on the screen automatically when system boot up. User can manually to enable by clicking the **CPU Meter** button.

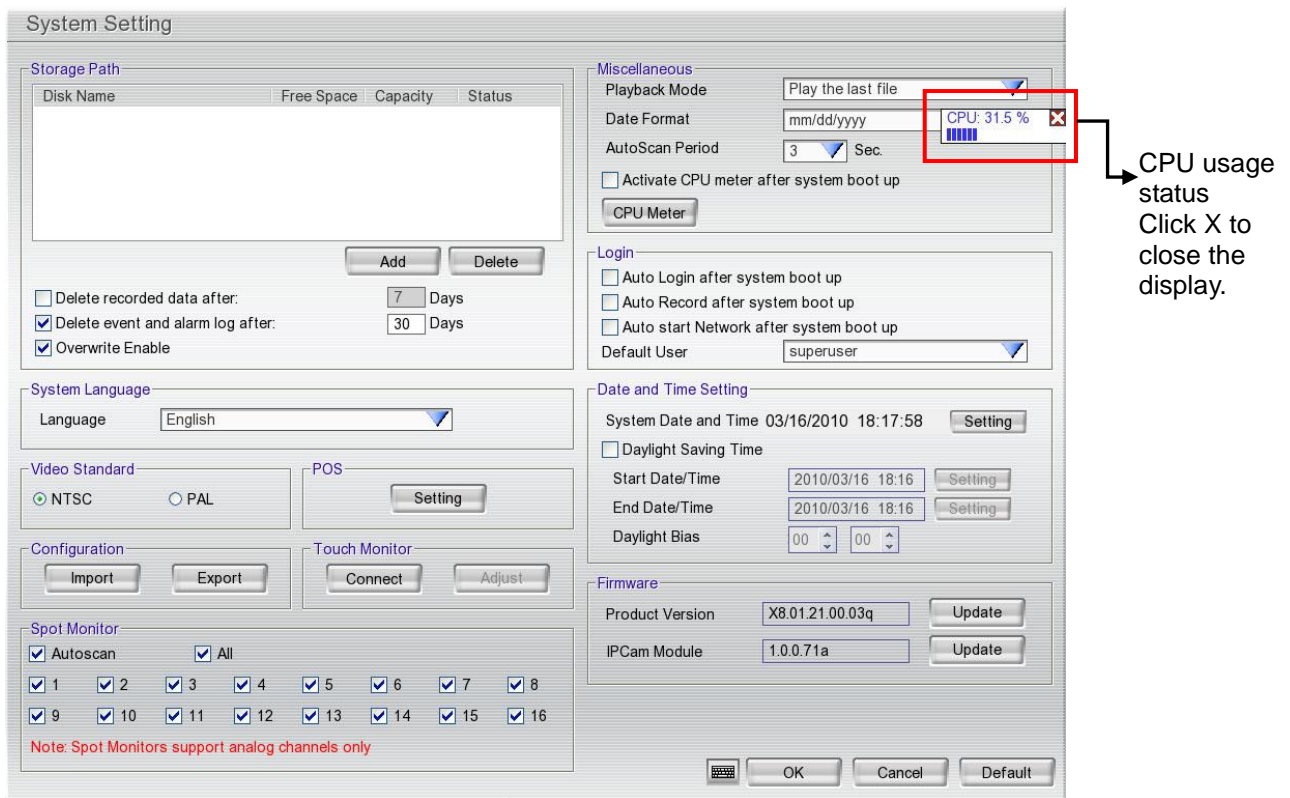

(12) Login

Enable the conditions in Login section you want the system to automatically carry out.

- **Auto Login after system boot up**
Execute the DVR when the operating system is started.
- **Auto Record after system boot up**
Automatically start video recording when the DVR is executed.
- **Auto start Network after system boot up**
Automatically start network connection when the DVR is executed.
- **Default user**
Automatically log in to the selected default user when the DVR is executed.

(13) Date and Time Setting

Adjust the DVR system time and date. Click **Setting** to select the month, date, hour, and minute.

Mark **Daylight saving** check box to enable daylight saving function. And then, select the **Start and End Date/Time** by click **Setting**.

Daylight Bias: Assign a time that it is for daylight saving time offset in your time zone. For example: if the time zone is in U.S. Eastern, the time offset is 1 hour.

(14) Firmware

- **Product Version Update:** Upgrading the firmware of DVR system.
 1. Save the firmware on root directory of USB pen drive. And then, plug USB pen drive to DVR server.
 2. Click **Update** button, a **Firmware Upgrade** windows will show up.



3. Select the USB pen drive if there is more than one USB storage device from drop down list. The DVR unit will auto detects the firmware.
4. Click **OK** to start upgrading.

■ **IPCam Module Firmware Update:** Update firmware of IP camera.

1. Save the firmware on root directory of USB pen drive. And then, plug USB pen drive to DVR server.
2. Click **Update** button, a **Firmware Upgrade** windows will show up.

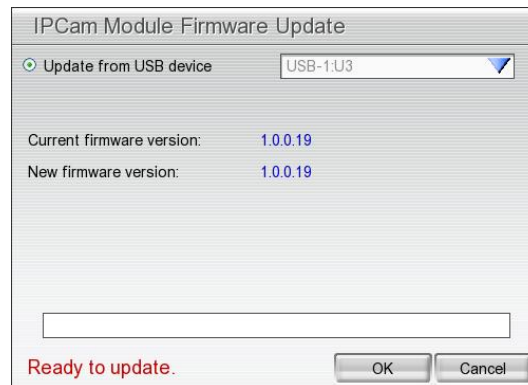

3. Select the USB pen drive if there is more than one USB storage device from drop down list. The DVR unit will auto detects the firmware.
4. Click **OK** to start upgrading.

3.2 Camera Setup

The DVR system supports 8/16 cameras in combination of analog and IP cameras, only analog cameras, or only IP cameras.

3.2.1 To Setup IP Camera(For EH series)

Click **Default** will back to the factory default value.



EH5108/EH5108H/EXR5008 series only has 8 channels will be available.

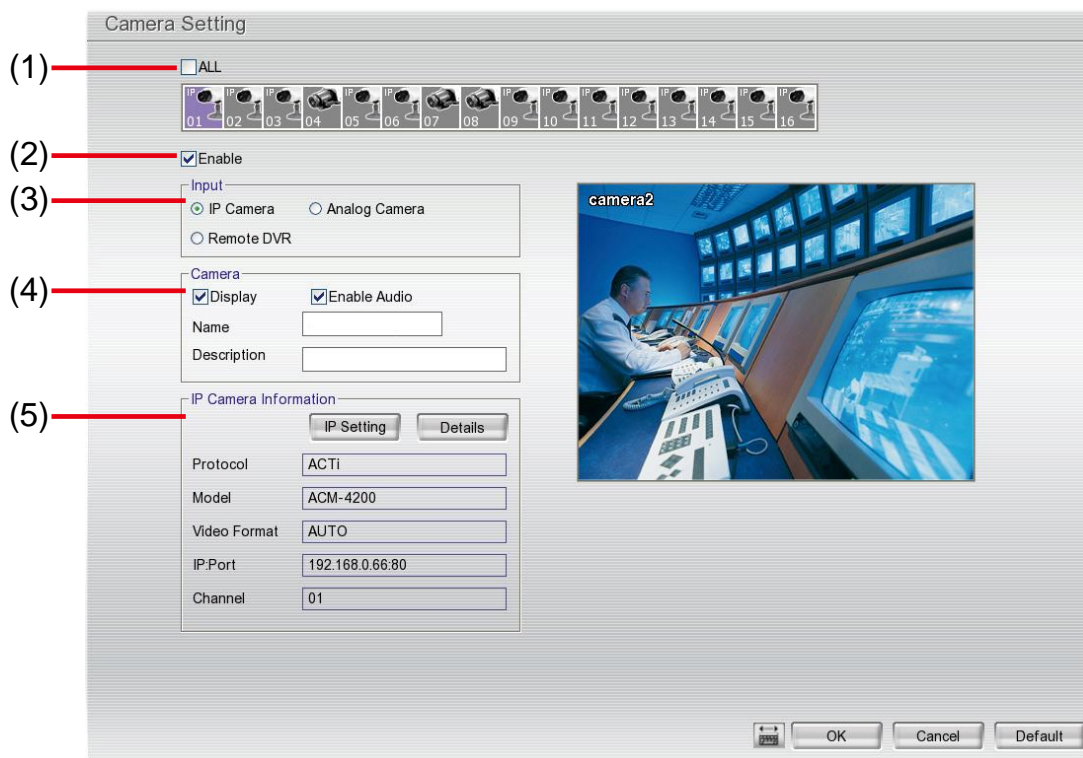

(1) Camera Icons

Select the camera number you want to view. To enable/disable all cameras, click **ALL** check box.

(2) Enable

Set to enable/disable the selected camera. When there is no video source on the camera, we suggest disabling it so that the system won't detect it as video loss error.

(3) Input

Select the camera type as **IP Camera**.

(4) Camera

- **Display**
Enable/disable to show the video. Even if the video of the selected camera is hidden you can still record the video and preview it in playback mode.
- **Enable Audio**
Enable/disable audio of the camera.
- **Name**
Change the camera name
- **Description**
Add a short comment

(5) IP Camera Information

To setup IP camera and display current IP camera information.

- **IP Setting:** Click **IP setting** to add the IP camera.

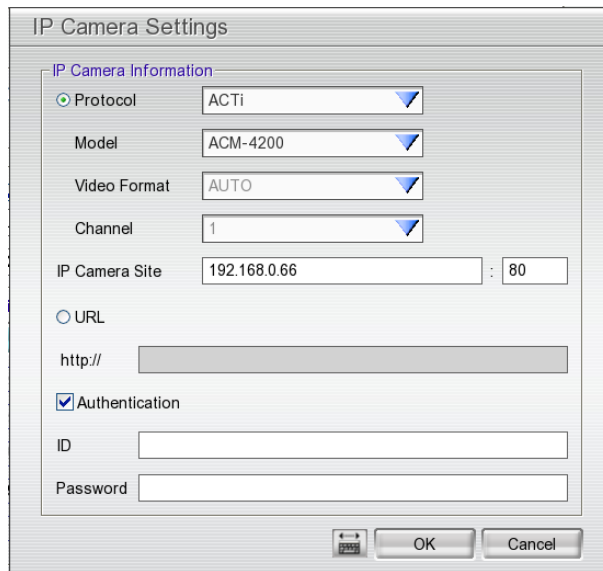

1. Click the radio button of **Protocol** to start setup IP camera.
2. Select the **Protocol**, **Model**, **Video Format**, and **Channel** of the IP camera.
3. Enter IP address and connecting port in **IP Camera Site** column.
4. Also, user can enter URL of IP camera instead of IP address.
5. If the IP camera has authority request, please enable **Authentication** and enter **ID** and **Password**.
6. Click **OK** to connect with the IP camera.

■ **Detail:** To adjust IP camera parameters, click **Detail**. Click **Default** will back to the factory default value.



User can select **Video size**, **Frame rate**, **Bitrate mode** and **Quality** of camera. Also, user can adjust **Bright**, **Contrast**, **Hue**, **Saturation**, and **I/O Control** of the camera.



The selection and adjustment items may vary by the camera supported.

I/O Control: Setup the sensor and relay that is embedded on the IP camera.

■ **Sensor Setting**

1. Click **Sensor** button.
2. Click the drop-down list and select the sensor ID number.
3. Enter sensor name in **Name** column
4. The system automatically detects the camera and input relates information. In the Content section, enter sensor **Description**.
5. In the test section, click **Test** to check the sensor status. **Red** is high and **Green** is low.
6. Click **OK** to exit and accept the setting and **Cancel** to exit without saving the setting.

■ **Relay Setting**

1. Click **Relay** button.
2. Click the drop-down list and select the relay ID number.
3. Enter relay name in **Name** column
4. The system automatically detects the camera and input relates information. In the Content section, enter relay **Description**.
5. In the test section, click **Test** to check the relay status. **Red** is high and **Green** is low.
6. Click **OK** to exit and accept the setting and **Cancel** to exit without saving the setting.

3.2.2 To Setup IP Camera(For EXR series)

Click **Default** will back to the factory default value.

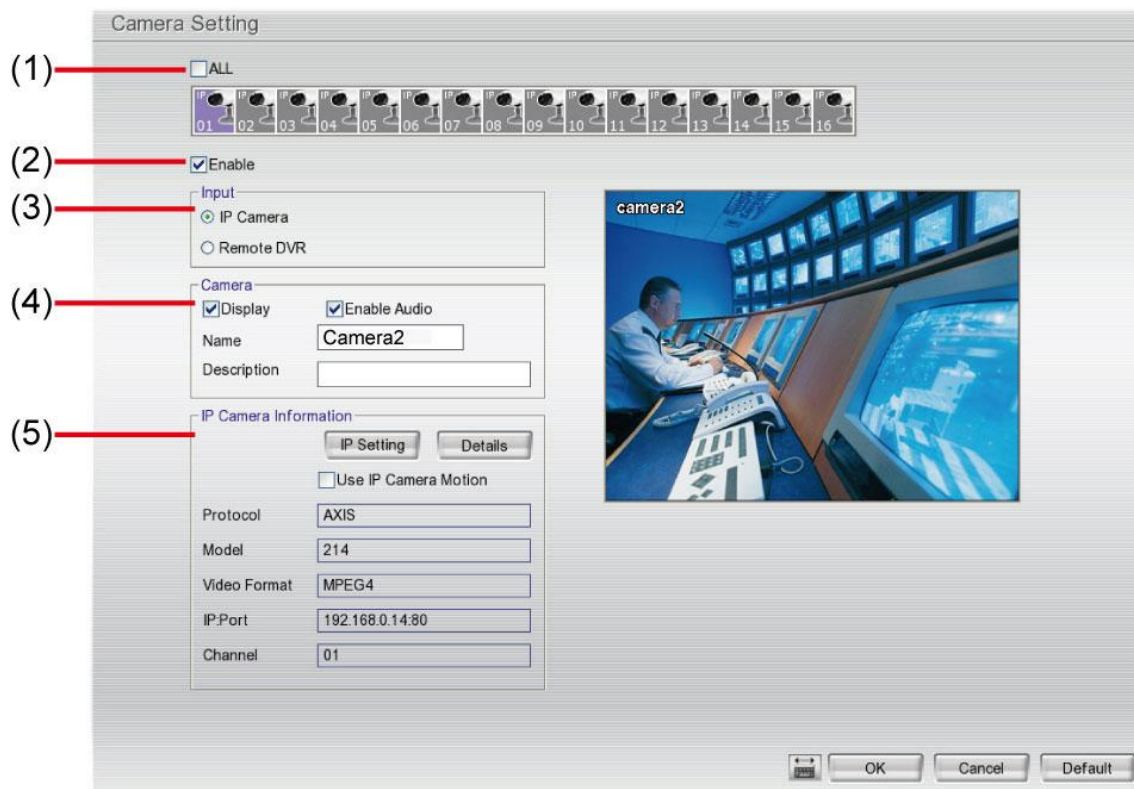

(1) Camera Icons

Select the camera number you want to view. To enable/disable all cameras, click **ALL** check box.

(2) Enable

Set to enable/disable the selected camera. When there is no video source on the camera, we suggest disabling it so that the system won't detect it as video loss error.

(3) Input

Select the camera type as **IP Camera**.

(4) Camera

- Display

Enable/disable to show the video. Even if the video of the selected camera is hidden you can still record the video and preview it in playback mode.

- Enable Audio

Enable/disable audio of the camera.

- Name

Change the camera name

- Description

Add a short comment

(5) IP Camera Information

To setup IP camera and display current IP camera information.

■ **Using IP Camera Motion:** Enable to use the motion detection function of IP camera if the IP camera has support motion detection and the motion recording will based on IP camera motion detection.

■ **IP Setting:** Click **IP setting** to add the IP camera.

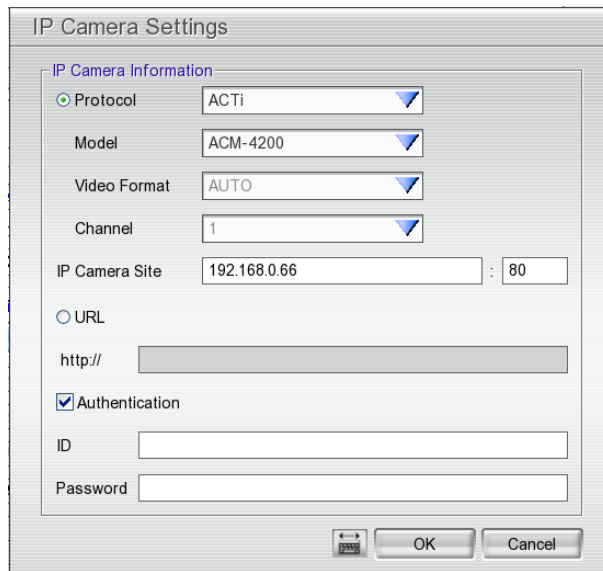

7. Click the radio button of **Protocol** to start setup IP camera.
8. Select the **Protocol**, **Model**, **Video Format**, and **Channel** of the IP camera.
9. Enter IP address and connecting port in **IP Camera Site** column.
10. Also, user can enter URL of IP camera instead of IP address.
11. If the IP camera has authority request, please enable **Authentication** and enter **ID** and **Password**.
12. Click **OK** to connect with the IP camera.

■ **Detail:** To adjust IP camera parameters, click **Detail**. Click **Default** will back to the factory default value.

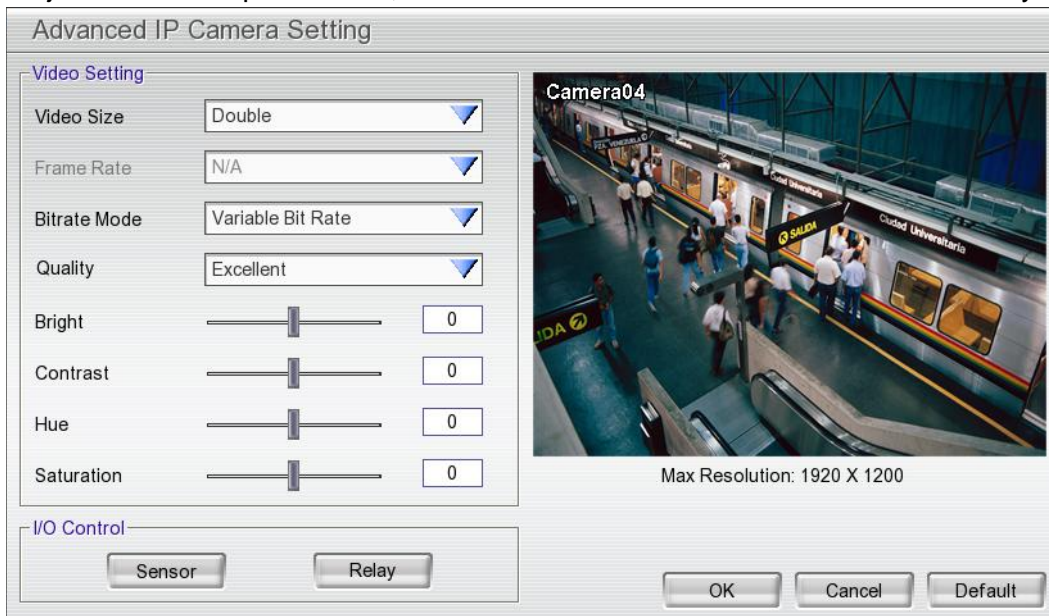

User can select **Video size**, **Frame rate**, **Bitrate mode** and **Quality** of camera. Also, user can adjust **Bright**, **Contrast**, **Hue**, **Saturation**, and **I/O Control** of the camera.



The selection and adjustment items may vary by the camera supported.

I/O Control: Setup the sensor and relay that is embedded on the IP camera.

■ **Sensor Setting**

1. Click **Sensor** button.
2. Click the drop-down list and select the sensor ID number.
3. Enter sensor name in **Name** column
4. The system automatically detects the camera and input relates information. In the Content section, enter sensor **Description**.
5. In the test section, click **Test** to check the sensor status. **Red** is high and **Green** is low.
6. Click **OK** to exit and accept the setting and **Cancel** to exit without saving the setting.

■ **Relay Setting**

1. Click **Relay** button.
2. Click the drop-down list and select the relay ID number.
3. Enter relay name in **Name** column
4. The system automatically detects the camera and input relates information. In the Content section, enter relay **Description**.
5. In the test section, click **Test** to check the relay status. **Red** is high and **Green** is low.
6. Click **OK** to exit and accept the setting and **Cancel** to exit without saving the setting.

3.2.3 To Setup Analog Camera(For EH series Only)

Click **Default** will back to the factory default value.



EH5108/EH5108H/EXR5008 series only has 8 channels will be available.

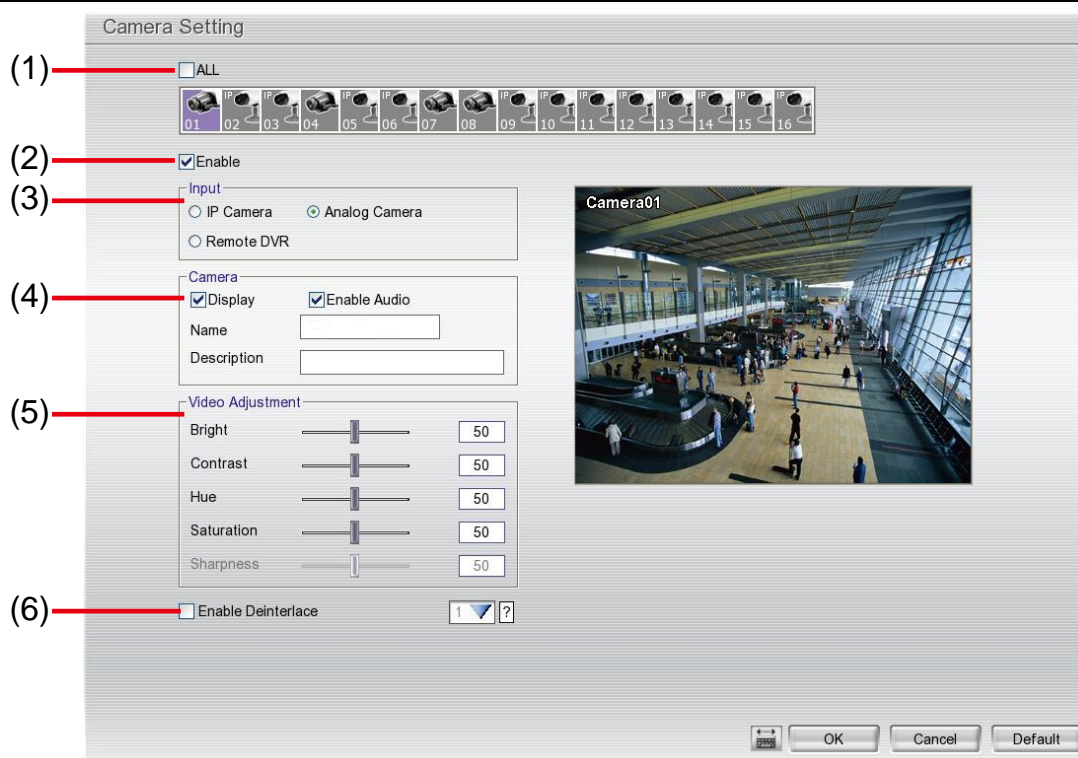

(1) Camera Icons

Select the camera number you want to view. To enable/disable all cameras, click **ALL** check box.

(2) Enable

Set to enable/disable the selected camera. When there is no video source on the camera, we suggest disabling it so that the system won't detect it as video loss error.

(3) Input

Select the camera type as **Analog Camera**.

(4) Camera

- **Display**
Enable/disable to show the video. Even if the video of the selected camera is hidden you can still record the video and preview it in playback mode.
- **Enable Audio**
Enable/disable audio of the camera.
- **Name**
Change the camera name
- **Description**
Add a short comment

(5) Video Adjustment

Adjust the Brightness, Contrast, Hue, Sharpness, and Saturation of the camera.

(6) Enable Deinterlace

Enhance the video quality. Set the **Enable Deinterlace** mode to #1, if you are capturing motionless picture and #2, if it captures lots of movement.

3.2.4 To Setup Camera from the Remote DVR

User can add the camera from another DVR through the network.

-  - EH5108/EH5108H/EXR5008 series only has 8 channels will be available.
- EXR series will not have the **Analog Camera** selection for input.

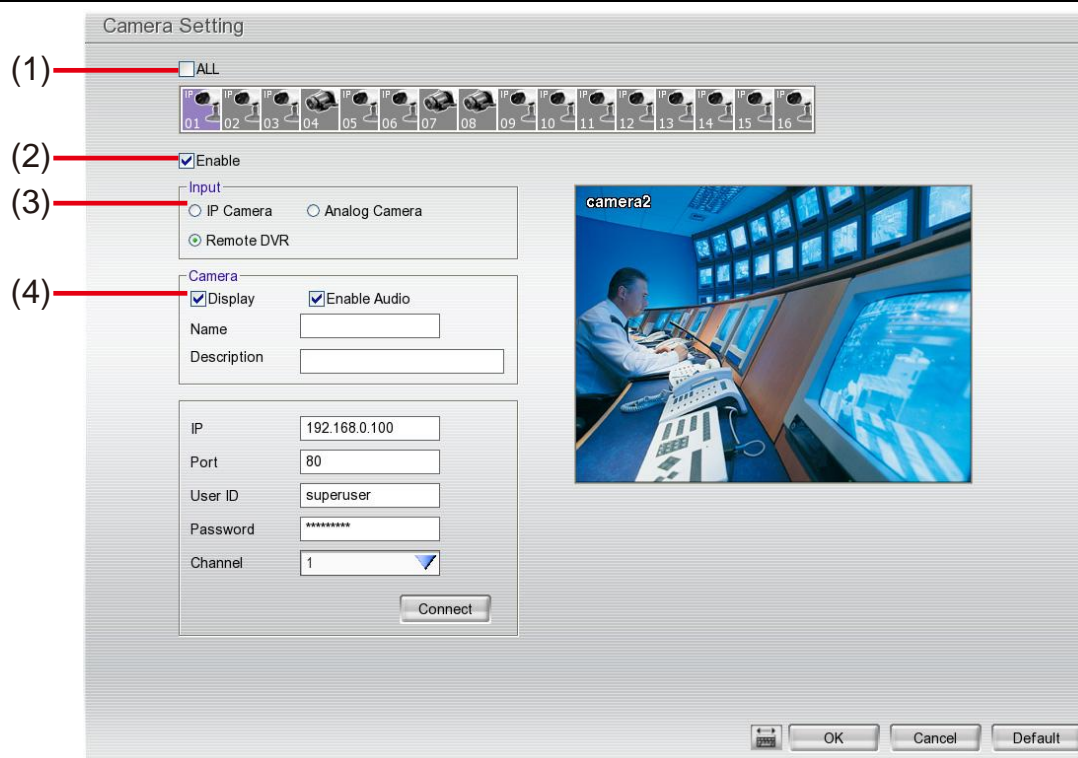

(1) Camera Icons

Select the camera number you want to view. To enable/disable all cameras, click **ALL** check box.

(2) Enable

Set to enable/disable the selected camera. When there is no video source on the camera, we suggest disabling it so that the system won't detect it as video loss error.

(3) Input

Select the camera type as **Remote DVR**.

(4) Camera

- **Display**
Enable/disable to show the video. Even if the video of the selected camera is hidden you can still record the video and preview it in playback mode.
- **Enable Audio**
Enable/disable audio of the camera.
- **Name**
Change the camera name
- **Description**
Add a short comment
- **IP**
Enter the IP address of the camera
- **Port**
The port for connection
- **User ID**
Enter the user id that for connecting authority
- **Password**
Enter the password that is for connecting authority

- **Channel**
Select the channel of connected camera
- **Connect**
Click to connect the camera when all configurations are set.

3.3 Recording Setup

3.3.1 Setup IP Camera Record Setting

i EH5108/EH5108H/EXR5008 series only has 8 channels will be available.

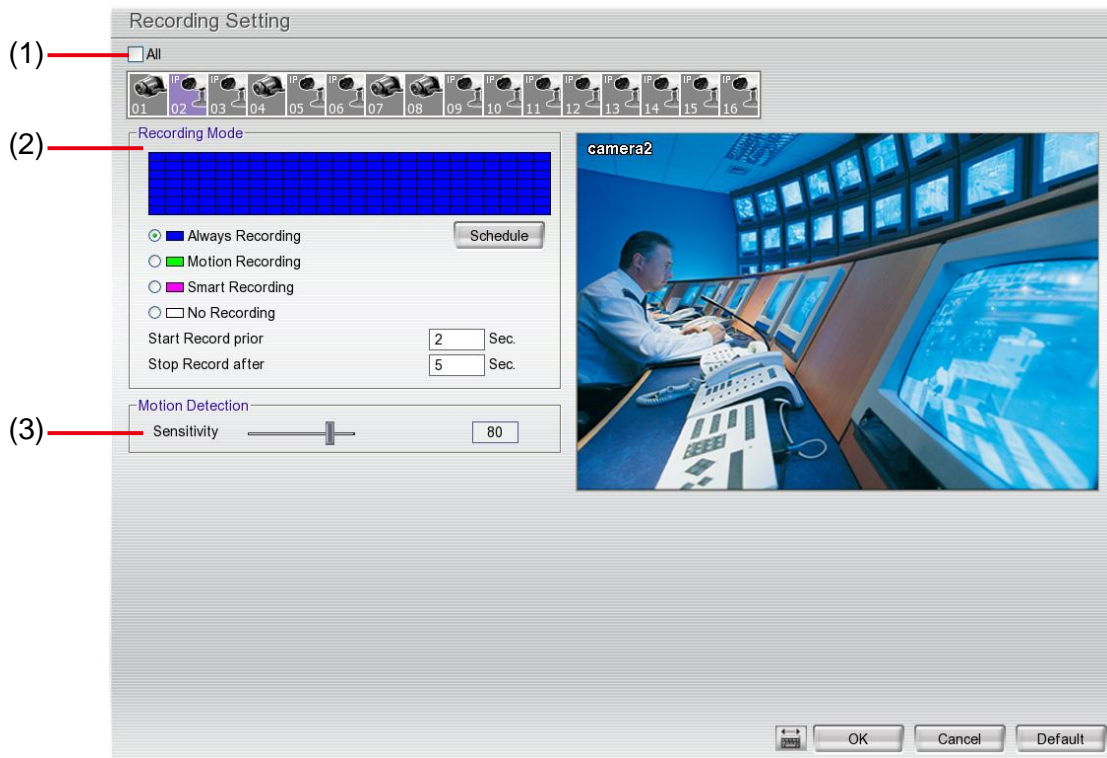

(1) Camera Icons

Select the camera number you want to set the recording setting. To select all the cameras, enable the **ALL** check box. To select more than one camera, **Right click** on the camera icon. To select one camera only, **Left click** on the camera icon. The camera icon turns purple when it is selected.

(2) Recording Mode

The horizontal blocks from 00 to 23 represent the time in 24-hour clock and the vertical block 1 to 7 represent the day in the week block (Sunday to Saturday). To record in full 24 hours and 7 days a week, select the recording mode and click the **Always Recording** button. If you want to only record at a particular time or day, click **Schedule** button and select the **Recording Mode**, and then click on the time or day blocks. When the system starts recording a red triangle mark would appear at the upper left corner of the screen. The recording modes are listed below:

- **Always Recording**
Record the video from the selected camera and save it to the designated storage device
- **Motion Recording**
Start recording the video from the selected camera only when the system detects movement. Once a motion is detected, the system automatically saves the previous frames and stop based on the **Start Record Prior** and **Stop Record After** settings.
- **Smart Recording**
Automatically switch to recorded at the maximum frame rate setting once a motion is detected and if there is no motion, it records at the minimum frame rate setting.

- No Recording

The system won't do any recording.

(3) Motion Detection

Adjust the sensitivity of the motion detection. The higher the value, the finer the sensitivity is detected. When it detects a motion, a green triangle mark would appear at the upper left corner of the screen.

i For EXR series, if motion detect of IP camera is enable (see also [Chapter 3.2.2](#)), the DVR system will based on the IP camera's motion detect setup for motion recording.

3.3.2 Setup Analog Camera Record Setting(For EH series Only)

Click **Default** will back to the factory default value.

i EH5108/EH5108H/EXR5008 series only has 8 channels will be available.

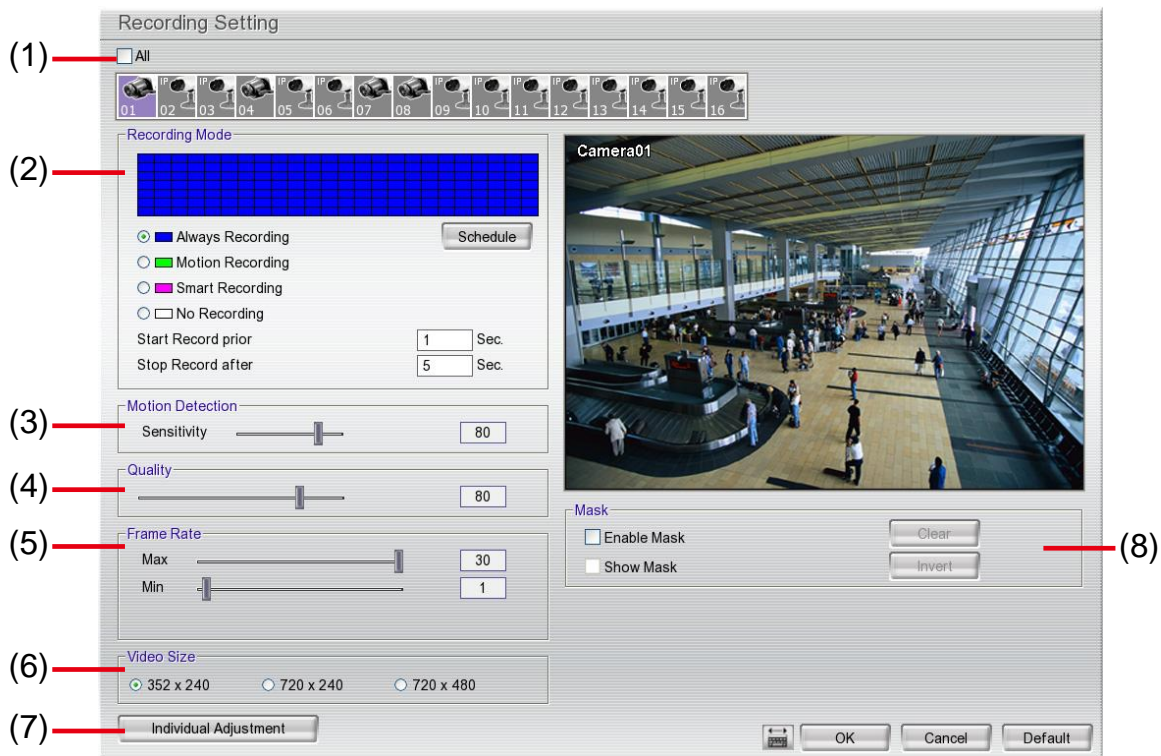

(1) Camera Icons

Select the camera number you want to set the recording setting. To select all the cameras, enable the **ALL** check box. To select more than one camera, **Right click** on the camera icon. To select one camera only, **Left click** on the camera icon. The camera icon turns purple when it is selected.

(2) Recording Mode

The horizontal blocks from 00 to 23 represent the time in 24-hour clock and the vertical block 1 to 7 represent the day in the week block (Sunday to Saturday). To record in full 24 hours and 7 days a week, select the recording mode and click the **☉** button. If you want to only record at a particular time or day, click **Schedule** button and select the **Recording Mode**, and then click on the time or day blocks. When the system starts recording a red triangle mark would appear at the upper left corner of the screen. The recording modes are listed below:

- Always Recording

Record the video from the selected camera and save it to the designated storage device

- Motion Recording

Start recording the video from the selected camera only when the system detects movement. Once a motion is detected, the system automatically saves the previous frames and stop based on the **Start Record Prior** and **Stop Record After** settings.

- Smart Recording

Automatically switch to record at the maximum frame rate setting once a motion is detected and recording time will be based on **Stop Record After** setting; if there is no motion, it records at the minimum frame rate setting. Set the frame rate in **(5) Frame Rate**.

- No Recording

The system won't do any recording.

(3) Motion Detection

Adjust the sensitivity of the motion detection. The higher the value, the finer the sensitivity is detected. When it detects a motion, a green triangle mark would appear at the upper left corner of the screen.

(4) Quality

Adjust the video quality. The higher the value, the lower the compression level and uses more hard disk space.

(5) Frame Rate

Set the maximum and minimum number of frames to be recorded during motion and motionless state. The frame rate ranges from 01 to 30 for NTSC and 01 to 25 for PAL. The higher the frame rate, it uses more hard disk space.

i Always recoding frame rate is depending on value of max frame rate.

(6) Video Size

Select the size of the video and click the **Ⓞ** button. The higher the size, the larger the file it create.

(7) Individual Adjustment

Each camera can adjust video size and frame rate individually. Click **Default** will back to the factory default value. The frame rate usage is shown in **Used** and **Unused** columns by CIF mode.

- i** - Adjusting video size and frame rate by channel, only available on the analog camera.
- EH5108/EH5108H/EXR5008 series only has 8 channels will be available.

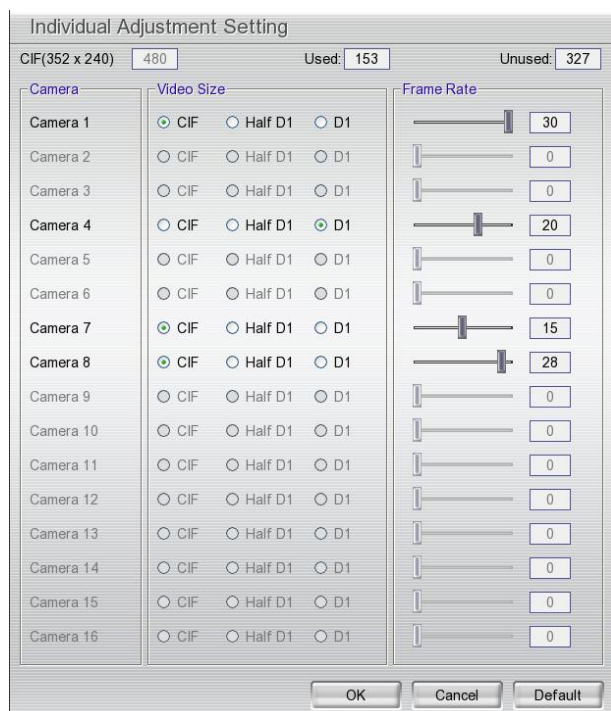

EH5216/EH5216H series UI

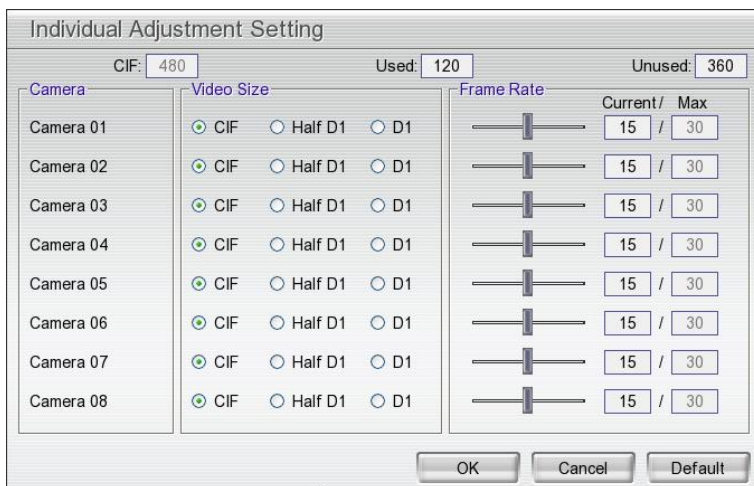

EH5108/EH5108H series UI

(8) Mask

Mark an area on the screen to disregards the motion in the marked area and to only monitor outside the marked area. Enable the **Enable Mask** and click-and-drag an area on screen that user wants to mask. To clear all mask area, click **Clear** button. To inverse the mask area, click **Invert** button. The original selected area will exchanged with un-selected area. To show the mask area on preview screen, enable **Show Mask**. The mask is able to see on the screen only when preview screen is in single screen mode

3.4 Network Setup

Click **Default** will back to the factory default value.



EH5108/EH5108H/EXR5008 series only has 8 channels will be available.

(1) Server Name

Assign a name for the DVR unit. Alphabet letters and numbers only.

(2) Transmitting Cameras

Select and click on the camera number in the Transmitting Camera section you want to make it accessible via internet using WebViewer, Remote Console, PDA Viewer and JAVAViewer (still image). To select all the cameras, enable the **ALL** check box.

(3) Main Configuration

Set the DVR IP address and **Remote Console Port**. You need this when accessing DVR server from the remote location via internet. Click **Setting** to setup DVR IP.

■ **Using the following IP address:** Assigns an IP address for the DVR system. Fill in the IP related parameters in **IP information** section.

- **IP:** Assign a constant IP address which a real IP address gives from ISP to DVR system.
- **Mask:** It is a bitmask used to identify the sub network and how many bits provide room for host addresses. Enter the subnet mask of the IP address which user has assigned to DVR system.
- **Gateway:** A network device acts as a passageway to internet. Enter the network gateway IP address

- **DNS:** Domain Name Server translates domain names (such as www.abb.com.tw) to IP addresses. Enter the IP address of DNS if it is available.
- **MAC Address:** An identifier hardware address of DVR unit that is assigned by the manufacturer for identification. User don't need to fill in, it will generated by system automatically.
- **Obtain an IP automatically (DHCP):** Assign the IP address by local DHCP server to DVR system.
- **PPPOE:** Point-to-Point Protocol over Ethernet is a network protocol for encapsulating PPP frames in Ethernet frames. It is used mainly with ADSL services. If your network is using ADSL service connecting to internet, and then, select PPPOE mode. Enter **User ID** and **Password** that is given by your ISP for PPPOE connecting authority.
- **DDNS:** DDNS(Dynamic Domain Name Service) is a data query service mainly used on the Internet for translating domain names into Internet addresses. Users can register their own domain name on <http://ddns.avers.com.tw>. (See [Appendix A](#))
 - **Domain Name**
Enter the domain name that user has registered.
 - **Password**
A password use to access DDNS that user has setup when register the domain name
 - **DDNS Server Name**
Select your DDNS server. The default only has one DDNS server now. It may provide more DDNS in future.
 - **DDNS Server Port**
Fill in the port that connects to DDNS server. Default is 1053.

(4) Remote Upgrade Configuration

A port is using for the remote firmware upgrade through network.

(5) WebViewer Configuration

Activate **Enable Anonymous Login** to remotely access the DVR server without the need of password. Fill in the **WebViewer PORT** for remote accessing connection.

(6) Network Time Synchronization

Adjust the DVR system time same as network time server. Fill in the **Time Server** IP address or domain name and select the **Time Zone**. User can enable **Automatic Synchronize at** to set automatic synchronize time on a daily basis. Or, user can click **Synchronize Time Right Now** to adjust time right away.

(7) Other Configuration

- **Enable White List**

An access permit list for the remote accessing of DVR server. Enter the IP address and click **Add**. Or, enter a range of IP address and click **Add**. To delete the IP from the list, select the IP and click **Delete** button. To reset the input, click **Clear** button.

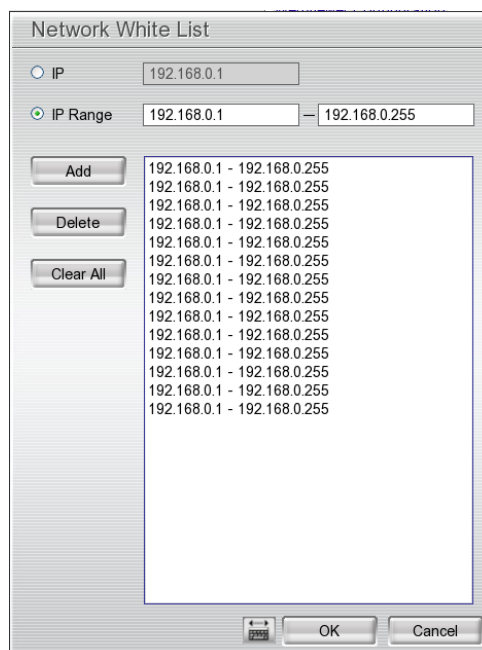

- **Network Bandwidth Limit**

By Channel: Set the network bandwidth by each channel.

All: Set the total network bandwidth consumption limit.

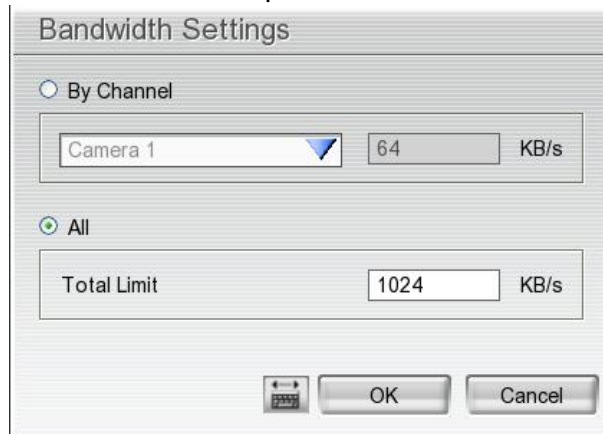

The image shows a 'Bandwidth Settings' dialog box with a title bar. It contains two radio button options: 'By Channel' (unselected) and 'All' (selected). Under 'By Channel', there is a dropdown menu showing 'Camera 1' and a text input field containing '64', followed by 'KB/s'. Under 'All', there is a text input field containing '1024', followed by 'KB/s'. At the bottom, there are three buttons: a help icon, 'OK', and 'Cancel'.

3.5 Schedule Setting

Schedule to record, enable network, reboot and disable alarm of all the cameras either weekly or one time. The number from 00 to 23 represent the time in 24-hour clock. The left most column display the days in a week.

The screenshot shows the 'Schedule Setting' window. At the top, there's a calendar for '2008/07' with navigation arrows. Below the calendar is a dropdown menu currently set to 'Record'. To the right of the dropdown are three radio button options: 'Weekly' (selected), 'One Time', and 'Remove'. Below these options is a large grid with days of the week (Sun-Sat) as rows and time slots (00-23) as columns. At the bottom of the window are five buttons: 'Save', 'Clear', 'All', 'OK', and 'Cancel'.

To Set the Schedule Setting:

1. Select the date in the calendar. Use ◀ and ▶ buttons to shift the calendar to the left or right.
2. Select the condition you want to schedule in the drop down list.
 - **Record**
Activate all the cameras to start video recording at the set time based on the Recording setting
 - **Enable Network**
Activate DVR remote system to access at the set time. After the appointed time, the Network function will be disabled. If the Network function is already enabled, the Network function will not be disabled when the appointed time has ended.
 - **Reboot**
Restart the PC at the appointed time.
 - **Disable Alarm**
Deactivate the alarm at the set time temporarily.
3. Set the schedule as weekly or one time. Click to make a selection.
4. Click on the blocks to set the schedule or click **All** to select all. To un-select the specific schedule blocks, click the **Remove** and click blocks to un-select. To store the setting, click **Save**. To remove the settings, click **Clear**.
5. To end Schedule Setting, click **OK** to exit and accept the setting and **Cancel** to exit without saving the setting.

3.6 Backup Setup



While backup, the CPU usage will be near to 100% and might slow down the DVR system response.

In the Backup Setting dialog box, the number from 00 to 23 represent the time in 24-hour clock. The numbers from 01 to 16 represent the camera number. When you back up the file, you may find Qplayer application included in the backup folder. User need to execute the Qplayer installation on PC for playback (see also [Chapter 3.6.1](#)).

The screenshot shows the 'Backup Setting' dialog box. At the top, there is a calendar for the month of November 2009. Below the calendar, there are two checkboxes: 'Include Player when backup' (unchecked) and 'Delete recorded files after Backup' (unchecked). There is a 'Save path' dropdown menu set to 'N/A' and a 'Folder Name' text box containing 'Backup'. To the right of these options are two buttons: 'Rescan Device' and 'Backup Now'. Below the 'Backup Now' button is a table with 16 rows (camera numbers 01-16) and 24 columns (times 00-23). The row for camera 12 is highlighted in blue. At the bottom of the dialog are three buttons: 'All', 'Clear All', and 'Exit'.

EH5216/EH5216H series UI



1. Select the date of the recorded file in the calendar you want to backup. Use and buttons to shift the calendar to the left or right.
2. In the table below, click on the blue block to select the recorded file or click camera (01~16) or time (00~23) to select the whole row or column. The blue block turns red when it is selected. The block that appears in white doesn't have data.
3. Check the space need for backup beside the calendar. Click **Rescan Device** to calculate the space for backup.
 - **Require Space**: Show the total size of the backup file.
 - **Free Space**: Show the available storage space
4. If user wants to include the Qplayer program in backup folder, mark the **Include Player when backup** check box. The Qplayer program will be in backup folder for playback using.
5. If you do **NOT** want to keep the recorded file in the storage folder, enable **Delete files after Backup** check box.
6. Select the backup device – USB disk or DVD-ROM device.
7. DVR system will give **Folder Name** automatically.
8. Click **Backup Now** button to start archiving the selected file.

3.6.1 Using QPlayer to Playback Backup Video

You can playback the backup files by using QPlayer applications on the PC. When you back up the recorded file, QPlayer applications are automatically included in the backup folder if user has enabled the selection of **Inclue player when backup** when backup recorded file. With QPlayer, it is the same as in Playback mode and supports different split screen types to view all the video at the same time. The only difference is that there are no Preview and Playback buttons.

To run the application, go to backup folder and double-click **Oplayer.exe**.



| Name | Function |
|--|---|
| (1) Exit | To close the application |
| (2) Split Screen Mode | Select from 6 different split screen type to playback the recorded video file of all the camera, or one camera over the other or alongside on a single screen. |
|  (3) Progress bar | - If there are only 8 cameras, when user select 13 and 16-split screen mode, only 8 channels have the video display and rest of channels will be black screen. - To zoom in an area on the screen, Right click and Drag a square on the area you want to enlarge. |
| (3) Progress bar | Show the progress of the file being played. You may move the bar to seek at any location of the track. |
| (4) Hour Buttons | Select and click to playback the recorded video file on the specific time frame. |
|  (5) Playback Control Buttons | The Hour buttons represent the time in 24-hour clock. The blue bar on top of the hour button indicates that there is a recorded video file on that period of time. While the red bar indicates that you are currently viewing the recorded video file. |
| (5) Playback Control Buttons | Begin: Move at the beginning of the recorded video file. Previous: Go back to the previous frame. Slower: Play the recorded video file at the speed of 1/2X, 1/4X, 1/8X, 1/16X, or 1/32X. Rewind: Wind back the recorded video file. Pause: Briefly stop playing the recorded video file. Play: Play the recorded video file. Faster: Play the recorded video file at the speed of 2x, 4x, 8x, 16x, or 32x. Next: Go to the next frame. End: Go to the end of the recorded video file. |

| Name | Function |
|------|----------|
|------|----------|

- (6) Archive
- Select the date on the calendar and the time from 00 to 23 to where to start playing the recorded video file.
- **OPEN FILE:** user can open the recorded file from HDD
 - **Channel 01~ 16&Channel 17 ~ 32:** If the channels are over 16, click button to switch to different channel group of playback calendar.
 - **Day Light Saving:** the playback calendar will show the available video records during day light saving time period.

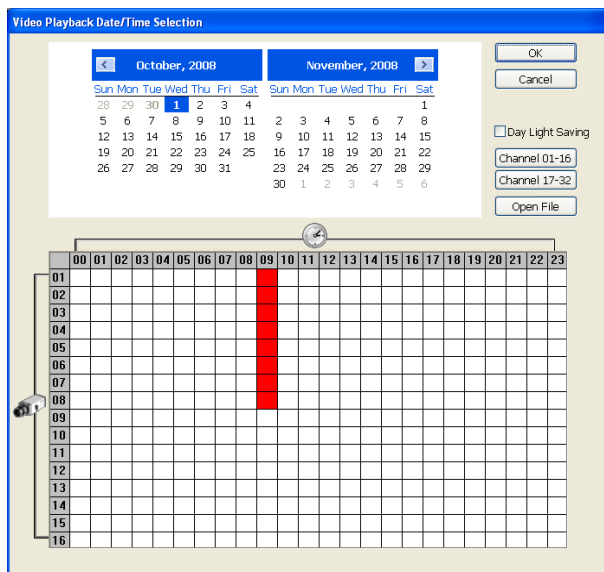

i The numbers from 00 to 23 represent the time in 24-hour clock. The numbers from 01 to 16 represent the camera ID. The blue colored column indicates that there is a recorded video file on that period of time. While the red colored column indicates on where to start playing the recorded video file.

- | | |
|------------------|--|
| (7) Status bar | Display the recorded date, time and play speed. |
| (8) Camera ID | Show the number of cameras that are being viewed. When you are in single screen mode, click the camera ID number to switch and view other camera. |
| (9) Language | Customize the system to display the tool tips and dialogs based on the selected language. By default the language is in English. |
| (10) Export | Export includes Snapshot, Print, and Output Video Clip function. <ul style="list-style-type: none"> ■ Snapshot: Capture and save the screen shot either in *.jpg format. ■ Print: Print the screen shot. ■ Output Video Clip: Save the segmented file in *.dvr format. |
| (11) Segment | Keep a portion of the recorded video (see also Chapter 3.6.2). |
| (12) Full screen | View in full screen mode. To return, press the right button of the mouse or ESC on the keyboard or click the arrow icon. |



Click to exit from full screen mode

When you switch to full screen in multiple-screen mode, **Left** click to toggle to only display one of the video in the multiple-screen mode or all.

| Name | Function |
|-------------------------|--|
| (13) Find Next | Search for the next event or changes in the motion detector frame. You can use this when you are using Intelligent Search or Event Search function. |
| (14) Event Search | Search from the recorded activities that were recorded in event log (i.e., Sensor, Motion, Video Loss). (See also Chapter 3.6.3) |
| (15) Intelligent Search | Search the changes in the motion detector frame (See also Chapter 3.6.4). |
| (16) Audio | Enable/disable volume |
| (17) De-interlace | To enhance the video quality. Set the de-interlace mode to #1, if you are capturing motionless picture and select #2, if it captures lots of movement. |

3.6.2 To Cut and Save the Portion of the Recorded Video

1. Use the Playback Control buttons or drag the bar on the playback progress bar and pause on where you want to start the cut. Then, click **Segment** to set the begin mark.



2. Use the Playback Control buttons or drag the bar on the playback progress bar and pause on where you want to end the cut. Then, click **Segment** to set the end mark. To cancel segmentation, click **Segment** button again.



3. Click **Export > Output Video Clip** button to save the wanted portion.
4. In the **Save As** dialog box, locate on where user wants to save the file, type the filename, and select the video format.

3.6.3 To Search Using the Event Search

1. Click on the video screen on where you want to search.
2. Click **Event Search**. The Event Search text (red) would appear at the lower left corner of the screen.
3. In the Event Search Setting dialog box, check the type of condition you want to search. The video search would stop at the frame that matches the condition. To keep on searching click **Find Next** (Find Next) button.
4. You may also set to search and list all the result. In the **Search Duration** section, set the **Begin Time** and **End Time**. Set the **Searching Interval** time that system won't list out the same events in a period of time that user has setup. Then, click **OK** to start searching.
5. When the Event list appear, click and select the item you want to view.

3.6.4 To Search Using the Intelligent Search

1. Click on the video screen on where you want to search.
2. Click **Intelligent Search**. The Intelligent Search text (red) would appear at the lower left corner of the screen.
3. When the Intelligent Search Setting dialog box and motion detector frame appear, you may adjust the sensitivity bar and the motion detector frame size and location. To set motion detector frame size and location, left click and drag on the screen. Then, click **OK** to start searching. The video search would stop at the frame that matches the condition. To keep on searching click . You may also set to search and list all the result. Just check the **List** box. In the **Search Duration** section set the **Begin Time** and **End Time**. Set the **Searching Interval** time that system won't list out the same events in a period of time that user has setup. Then, click **OK** to start searching.



3.7 Sensor Setting

The I/O device must be installed to use this function.

1. Click the drop-down list and select the sensor ID number.
2. Enter sensor name in **Name** column.
3. The system automatically detects the card and input number. In the **Content** section, enter **Description** of sensor.
4. In the test section, click **Test** to check the sensor status. **Red** is high and **Green** is low.
5. Click **OK** to exit and accept the setting and **Cancel** to exit without saving the setting.

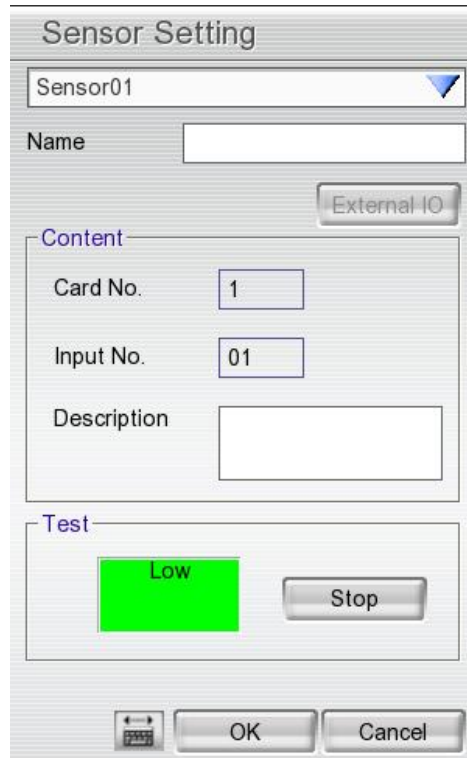

The image shows a 'Sensor Setting' dialog box with the following fields and controls:

- A drop-down menu at the top showing 'Sensor01'.
- A 'Name' text input field.
- An 'External IO' button.
- A 'Content' section containing:
 - 'Card No.' with a text input field containing '1'.
 - 'Input No.' with a text input field containing '01'.
 - 'Description' with a larger text input field.
- A 'Test' section containing:
 - A green rectangular indicator labeled 'Low'.
 - A 'Stop' button.
- At the bottom, there is a keyboard icon, an 'OK' button, and a 'Cancel' button.

3.8 Relay Setting

The I/O device must be installed to use this function.

1. Click the drop-down list and select the relay ID number.
2. Enter relay name in **Name** column.
3. The system automatically detects the card and input number. In the Content section, enter **Description** of relay.
4. In the test section, click **Test** to trigger relay. **Red** is high and **Green** is low.
5. Click **OK** to exit and accept the setting and **Cancel** to exit without saving the setting.

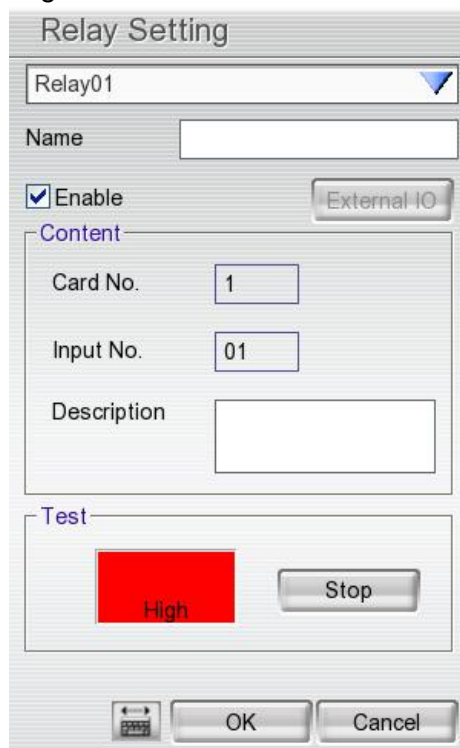

The image shows a 'Relay Setting' dialog box with the following fields and controls:

- A drop-down menu at the top showing 'Relay01'.
- A text input field labeled 'Name'.
- A checked checkbox labeled 'Enable' and a button labeled 'External IO'.
- A section titled 'Content' containing:
 - 'Card No.' with a text input field containing '1'.
 - 'Input No.' with a text input field containing '01'.
 - 'Description' with a text input field.
- A section titled 'Test' containing:
 - A red rectangular indicator with the word 'High' written on it.
 - A button labeled 'Stop'.
- At the bottom, there are three buttons: a left-pointing arrow, 'OK', and 'Cancel'.

3.9 Alarm Setting

In the Alarm Setting dialog box, click **Add** to insert and set new alarm setting, click **Delete** to remove the selected alarm setting, click **OK** to exit and save the setting, **Cancel** to exit without saving. Click **Default** will back to factory default value.

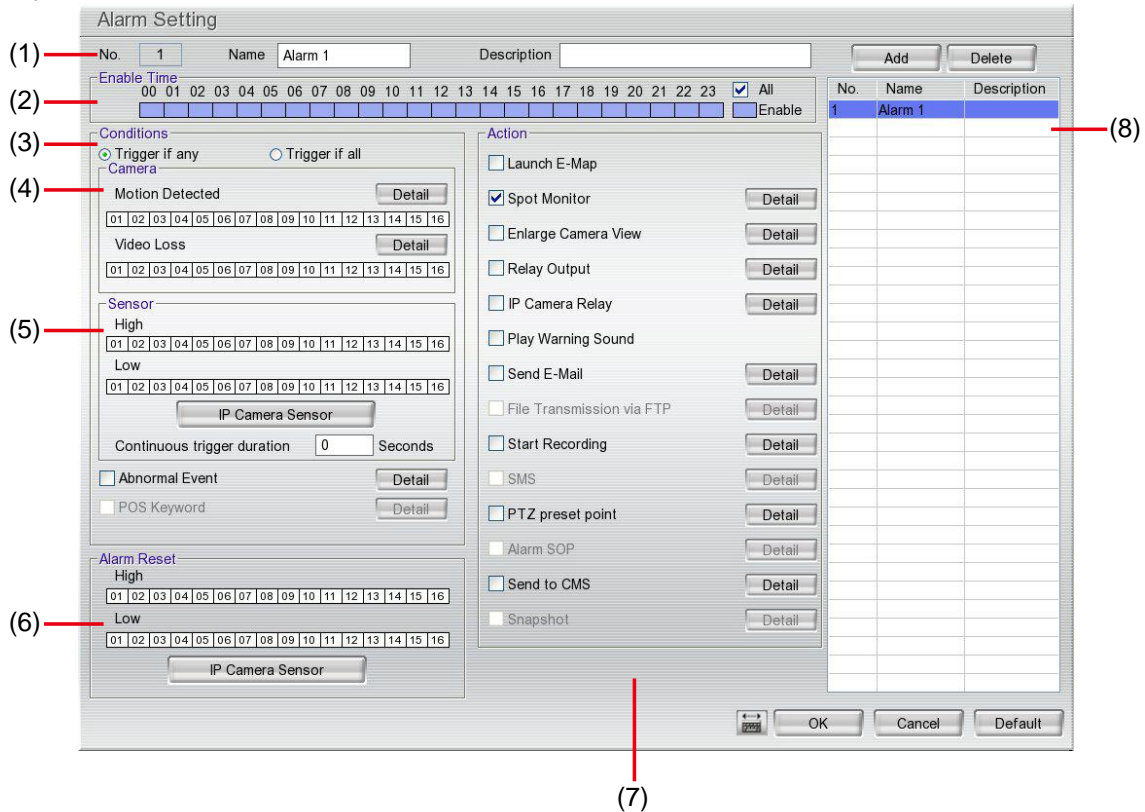

1. Click **Add** to insert and set a new alarm setting. Click the items in the **(8) Alarm Setting List** if you want to modify the alarm setting.
2. In **(1) No./Name/Description** enter alarm name and description. Alarm **No.** will be created by DVR system.
3. In **(2) Enable Time**, the number from 00 to 23 represent the time in 24-hour clock. Select the time and click the block you want to activate or deactivate the alarm function. When it is deactivated the color of the block turns white.
4. In **(3) Conditions**, you can set **“Trigger if any”** to activate if it falls to one of the conditions or **“Trigger if all”** to activate if it falls to all conditions.
5. In **(4) Camera** section, select and click on the camera number (01 to 16) in **Motion Detected** and **Video Loss** to set the condition for the system to alarm.
6. In **(5) Sensor**, select and click on the sensor number to set the condition for the system to alarm. If the sensor normal status is high, set the sensor condition to low.
 - **IP Camera Sensor:** To adjust sensor high/low that is connected on the IP camera.

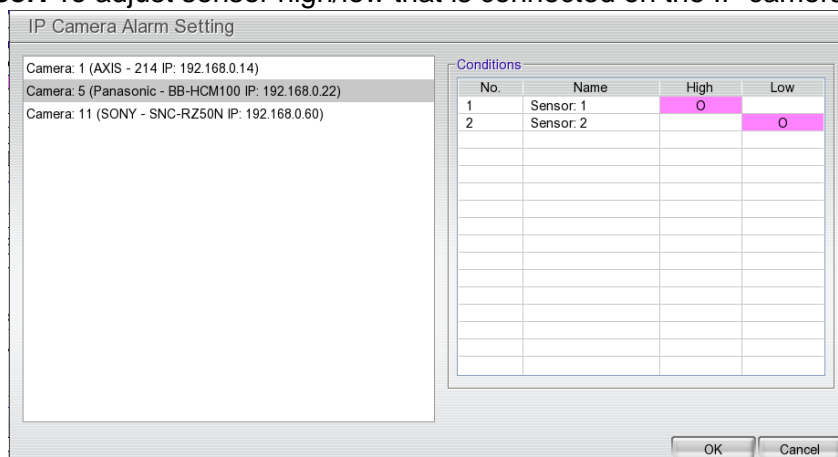

- Enable/disable the **Abnormal Event** check box, to set the condition of the event for system to alarm.



- **Reboot:** when the DVR system reboot without abnormal condition, the system will send out the alarm message.
 - **Abnormal Reboot:** when the DVR system reboot in irregular condition, the system will send out the alarm message.
 - **Recording is switched off:** when the recording has been stopped, the system will send out the alarm message.
 - **Network is switched off:** when the network connection of DVR system is lost, the system will send out the alarm message.
 - **Hard Disk failed:** when the hard disk doesn't work normally, the system will send out the alarm message.
- **Continue trigger duration:** Set a time period that when sensor has been trigger and stay in the same status for that period, then the alarm will be sent out.
7. In **(6) Alarm Reset**, click the camera number to set the reset condition of alarm. Once alarm is reset, all alarm action will stop at the moment. If the sensor normal status is high, set the alarm reset condition to low. Click **IP Camera Sensor** to configure sensor status of IP camera. Click **High/Low** to set sensor status to high or low.

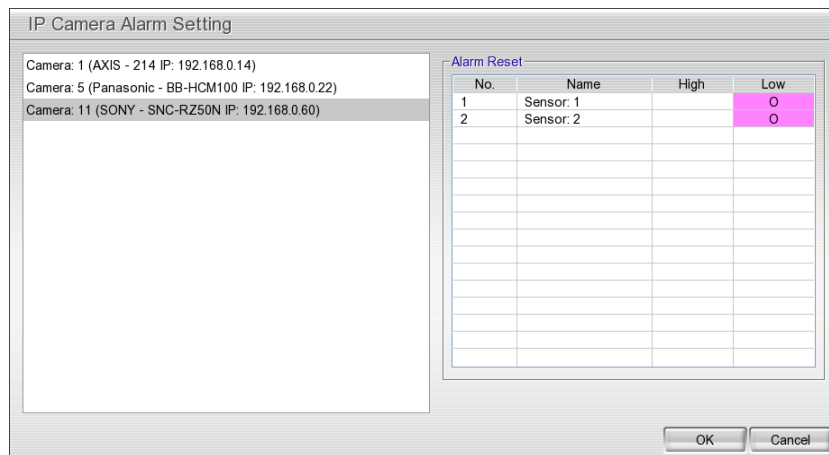

8. In **(7) Action**, you may now set the alarm action for the system to perform when the alarm condition is activated.
- **Launch E-Map:** Display mini E-map screen.
 - **Spot Monitor**
When the DVR system receives the alarm, the alarm video will display on spot monitor.
Mark **Spot Monitor 1/Spot Monitor 2** to enable the sport monitor function. And then, select the camera (channel) when the DVR system receives the alarm from the selected camera will display the alarm video on the spot monitor.

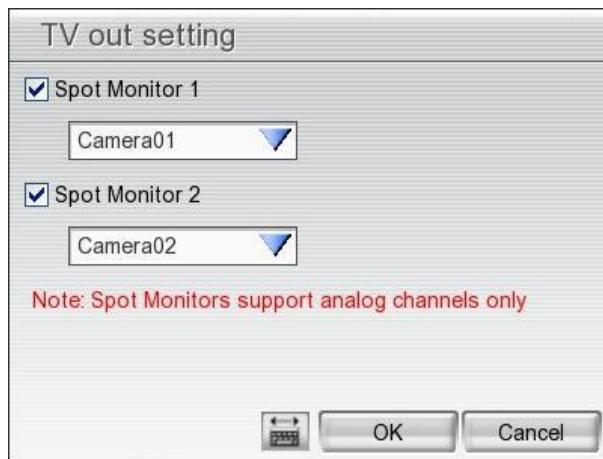

- Enlarge Camera View

Switch to only display video in Preview mode from where the alarm is activated.

- a. Select the camera from drop down list to specify which camera video to be enlarged on screen when the alarm is triggered.
- b. **Retrieve time:** set the waiting duration before system switching back to original Preview mode. If the retrieve time is un-mark, the alarm video will keep enlarging until user switch back to Preview mode manually. The retrieve time range is 0~ 600 seconds.



- Relay Output

Set to enable/disable the relay operation when the alarm is activated and to extend additional time in second before it stops the relay operation.

1. Beside the Relay Output check box, click **Detail**.
2. In the Alarm Relay dialog box, select from the available relay list and in the ON column, set to enable/disable the relay operation when the alarm is activated.
3. In the Retrieve time check box, you may enable/disable to extend the relay operation time and set the duration in second.
4. Click **OK** to exit and accept the setting and **Cancel** to exit without saving the setting.

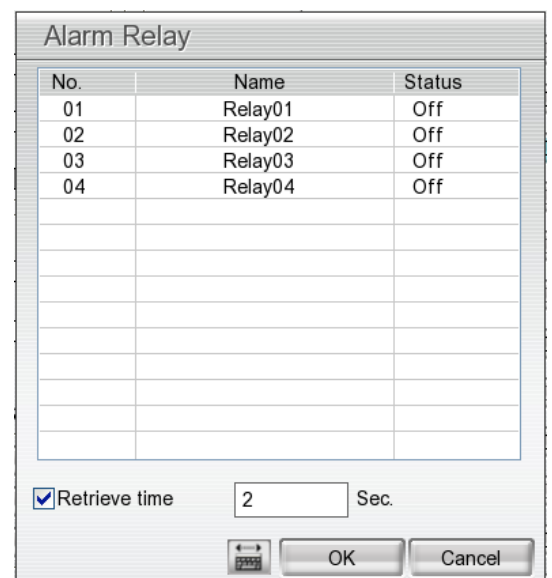

- **IP Camera Relay:** Set to enable/disable the relay operation when the alarm is activated.

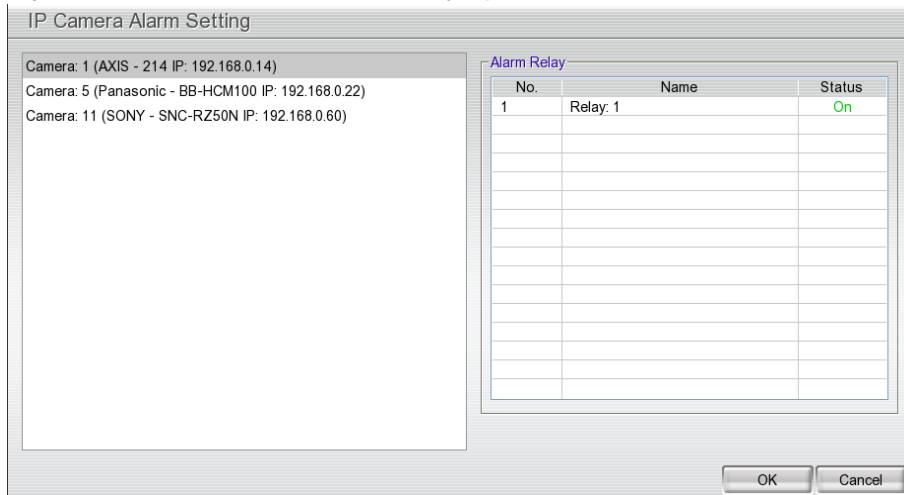

- **Play Warning Sound**

Play alarm sound.

- **Send E-mail**

Send an electronic text message. Beside the Send Email check box, click **Detail**.

In the E-mail Setting dialog box, click **OK** to exit and save the setting and **Cancel** to exit without saving the setting.

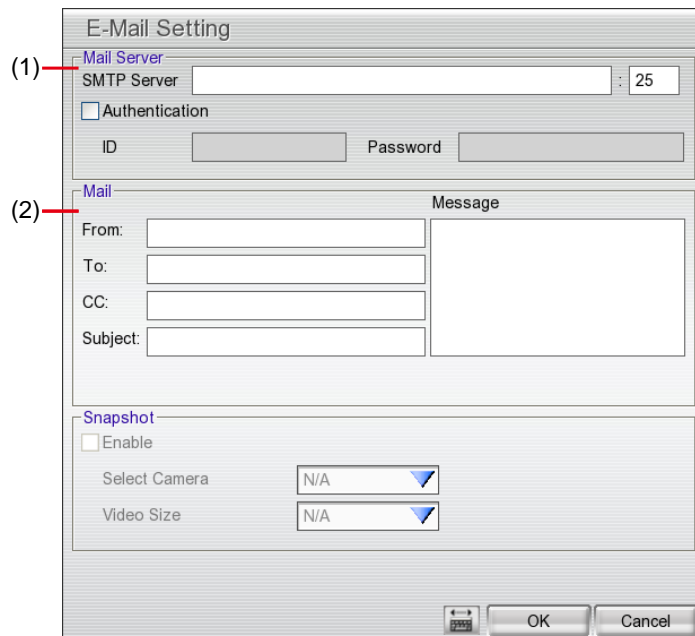

(1) Mail Server

Enter the **SMTP Server** and **port**. If your e-mail system requires user identification, enable **Authentication** check box and enter **ID** and **Password**.

(2) Mail

Fill the mailing information.

From: Enter the sender e-mail address.

To and CC: Enter the recipient email address and separate it with comma or a semicolon (;).

Subject: Enter the message title.

Message: Type the message.

- **Start Recording**

Record the video from the selected camera.



EH5108/EH5108H/EXR5008 series only has 8 channels will be available.

1. Beside the Start Recording check box, click **Detail**.
2. In the Alarm Recording Setting dialog box, select the camera to enable/disable video recording. Enable **All** to select all cameras.
3. In the Frame Rate selection, select **As Setting** to record the number of frames based on the Recording Setting.
4. In the **Start Record prior** text box, mark and set the number in second for the program to begin recording after the alarm has been trigger. The time range is 1~10 seconds.
5. In the **Stop Record after** text box, mark and set the number in second for the program to continue recording after the alarm has ended. The time range is 1~999 seconds. If user doesn't mark and set the time, the alarm recording will continue recording until alarm is reset.
6. Click **OK** to accept the new settings and **Cancel** to exit without saving.

Alarm Recording Setting

All

Recording Cameras

1 2 3 4 5 6 7 8

9 10 11 12 13 14 15 16

Frame Rate

As Setting Max

Start Record prior 3 Sec.

Stop Record after 3 Sec.

OK Cancel

- **PTZ preset point**

Position the PTZ camera based on the preset point setting.

Beside the PTZ preset point check box, click **Detail**. In the Trigger PTZ Preset Setting dialog box, select the PTZ camera number then select the **Enable** check box. Select the position of the PTZ camera when the alarm is activated and ended. For the PTZ camera end point, user can also select on preset position or **Auto Pan** between preset position groups.

Trigger PTZ Preset Setting

Select Camera 01

Enable

Preset Number

Alarm Trigger

1 2 3 4 5 6 7 8

9 10 11 12 13 14 15 16

Alarm Close

1 2 3 4 5 6 7 8

9 10 11 12 13 14 15 16

AutoPan

1 - 4 5 - 8

9 - 12 13 - 16

OK Cancel

- **Send to CMS (Central Management System)**

Enable/disable the selected camera to send video to CMS when the alarm is activated.

Beside the Send to CMS check box, click **Detail**. In the CMS Setting, select the camera to enable/disable sending the video to CMS. Enable **All** to select all cameras. Then, click **OK** to accept the new settings and **Cancel** to exit without saving.

CMS Setting

All

Transmitting Cameras

1 2 3 4 5 6 7 8

9 10 11 12 13 14 15 16

OK Cancel



EH5108/EH5108H/EXR5008 series only has 8 channels will be available.

3.10 User Setup

Only administrator level authority can access User Setting. The maximum user accounts are 32.

In the User Setting dialog box, click **Add** to insert a new user, **Delete** to remove the selected user, **Edit** to modify the user control right, **OK** to exit and accept the setting, and **Cancel** to exit without saving the setting.

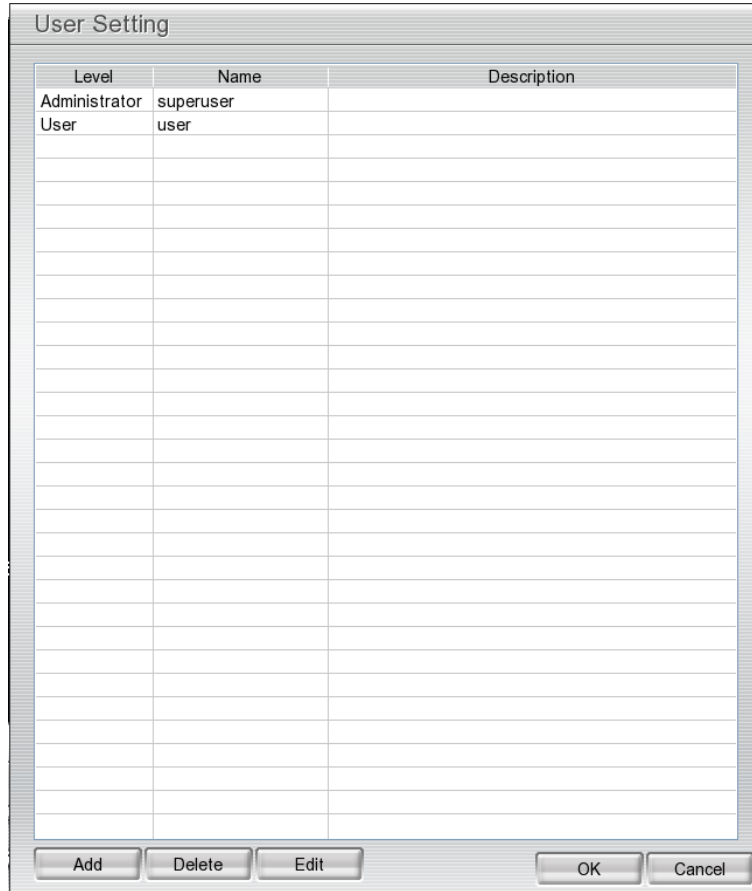

To Add a User Account:

1. In the User Setting dialog box, click **Add**.
2. Select and fill in the following information.

The screenshot shows the 'User Setting' dialog box with several sections and annotations:

- (1) Authorization Level:** Radio buttons for 'User' (selected) and 'Administrator'.
- (2) Control Right:** A list of checkboxes for various permissions: System Setting, Camera, Record, Network, Scheduler, Backup, Sensor, Relay, Alarm Setting, Playback, Power OFF, Reboot, PTZ, and E-Map. All are checked.
- (3) WebViewer:** Checkboxes for Remote Console, Remote Record, Remote LogViewer, and IP Camera, all unchecked.
- Remote Access time:** A checkbox for 'Infinite' (checked) and a 'Minute' field.
- Visible camera:** A section with a checked 'All' checkbox and 16 numbered checkboxes (1-16), all checked.
- (4) Time Span:** A section with an unchecked 'Enable' checkbox, 'Activation Date' and 'Expiry Date' fields with dropdown menus.
- (5) Name and Description:** Text input fields for 'Name' and 'Description'.
- (6) Password and Confirm Password:** Text input fields for 'Password' and 'Confirm Password'.
- Buttons for 'OK', 'Cancel', and 'Default' are at the bottom.

(1) Authorization level

Select the status of the user.

(2) Control Right

Enable the items that would allow the user to access.

(3) Web Viewer

Enable/disable Web Viewer control right that allow the user to operate from a remote location using internet explorer.

- **Remote Console**

Allow the user to remote modify DVR system setting.

- **Remote LogViewer**

Allow the user to view the event log from remote site.

- **IP Camera**

Enable/disable user to add new IP camera when using the Web Viewer.

- **Remote Access Time**

Enable **Infinite** check box to access DVR without time limit. If you want to set time limit, enter the number of minutes in **Minute** text box.

(4) Visible Camera

Select the camera number that would allow the user to access or view. To select all the cameras, enable the **ALL** check box.



EH5108/EH5108H/EXR5008 series only has 8 channels will be available.

(5) Time Span

Set the user account a specific time period that user only can use given account to login DVR program in that specific period. Mark **Enable** check box and select the **Activation Date** and **Expiry Date**.

(6) Name

Enter the user name.

Description

Enter the user description.

Password

Enter the user password.

Confirm Password

Enter the same user password for confirmation.

4.1 Recommended System Requirements

- Pentium®4 2.4GHZ or above
- Windows®2000/ XP/Vista/7
- DDR 256 MB
- Graphic function must support DirectDraw
- Audio card or built-in
- Speaker
- 1 available USB2.0 port

4.2 Installing the USB Playback Console

To install the USB Playback Console:

1. Place Installation CD into the CD-ROM drive. When the installation main screen appears, click **Install USB Playback Console** and then follow the on screen instructions

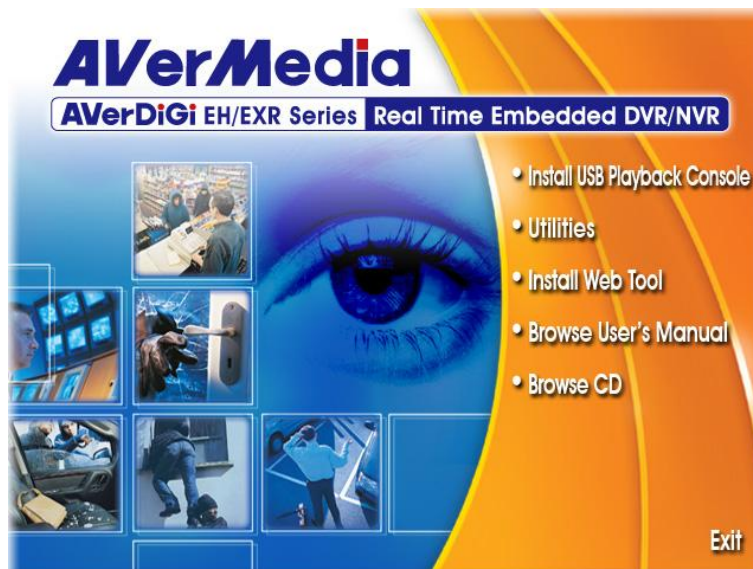

2. Select the language you prefer



3. Click **OK** to install the application.
4. Click **Exit** to close the installation main screen.
5. You may now connect the external USB storage device that has saved recorded files to PC.

4.3 Familiarizing the Buttons in USB Playback Console

To run the application, click the  icon on the PC desktop



| Name | Function |
|-----------------------|---|
| (1) Exit | Exit/Minimize the application or chose Cancel to go back to the application. About: shows DVR application version information. |
| (2) Progress bar | Show the progress of the file being played. You may move the bar to seek at any location of the track. |
| (3) Split Screen Mode | Select from different screen view to playback the recorded video file of the entire camera or one camera on screen. If there are only 8 cameras, you won't be able to switch to 13 and 16 split screen mode. |

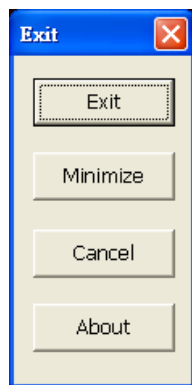

| Name | Function |
|------------------------------|---|
| (4) Playback Control Buttons | <p> Begin: Move at the beginning of the recorded video file.</p> <p> Previous: Go back to the previous frame by frame.</p> <p> Slower: Play the recorded video file at the speed of 1/2x, 1/4x, 1/8x, or 1/16x.</p> <p> Rewind: Wind back the recorded video file.</p> <p> Pause: Briefly stop playing the recorded video file.</p> <p> Play: Play the recorded video file.</p> <p> Faster: Play the recorded video file at the speed of 2x, 4x, 8x, or 16x</p> <p> Next: Go to the next frame by frame.</p> <p> End: Go to the end of the recorded video file.</p> |
| (5) Archive | <p>To select the video file source for playing.</p>  <ul style="list-style-type: none"> - DVR Recorded File (HD): To playback the recorded video from the hard disk which was recording video on the DVR system. (see also Chapter 4.3.2) - Backup File(.dvr): The file is backup and save in *.dvr file format. (see also Chapter 4.3.3) - Backup File(.avf): The file is backup and save in *.avf file format. (EH/EXR series doesn't support *.avf file format when backup). |
| (6) Status bar | Display the recorded date, time and play speed. |
| (7) Camera ID | Show the number of cameras that are being viewed. When you are in single screen mode, click the camera ID number to switch and view other camera. |
| (8) Language | To switch DVR application UI language. |
| (9) Adv. Function | <p>Advanced function is including :</p> <ul style="list-style-type: none"> ■ HDD Backup: to call out HDD Backup application. (see also Chapter 4.3.4) ■ iEnhance: to call out iEnhance application. (see also Chapter 6) ■ AVF to AVI: Convert the *.avf file to *.avi file(EH/EXR series doesn't support this function) |
| (10) Export | <p>Export includes Snapshot, Print, and Output Video Clip function.</p> <ul style="list-style-type: none"> ■ Snapshot: Capture and save the screen shot either in *.jpg or *.bmp format. ■ Print: Print the screen shot. ■ Output Video Clip: Save the segmented file in *.avi, *.mpeg, or *.dvr format |
| (11) Segment | Keep a portion of the recorded video (see also Chapter 4.3.1) |
| (12) Full screen | <p>Use the entire area of the screen to only display the video. To return, press the right button of the mouse or ESC on the keyboard.</p> <p>When you switch to full screen in multiple-screen mode, Left click to toggle to only display one of the video in the multiple-screen mode or all.</p> |
| (13) Visual Search | Search from a specific camera by Date, Hour, Minute, 10 Seconds and Second(see also Chapter 4.3.5). |
| (14) Find Next | Search for the next event. You can use this when you are using Event Search function. |
| (15) Event Search | Search from the recorded activities that were recorded in event log (i.e., Sensor, Motion, Video Loss). (see also Chapter 4.3.6) |

| Name | Function |
|-------------------------|--|
| (16) Intelligent Search | Search the changes in the motion detector frame(see also Chapter 4.3.7). |
| (17) Sound /Sound bar | Turn on and off the sound Adjust the volume |
| (18) De-interlace | To enhance the video quality. Set the de-interlace mode to #1, if you are capturing motionless picture and select #2, if it captures lots of movement. |

4.3.1 To Cut and Save the Portion of the Recorded Video

1. Use the Playback Control buttons or drag the bar on the playback progress bar and pause on where you want to start the cut. Then, click **Segment** to set the begin mark.



2. Use the Playback Control buttons or drag the bar on the playback progress bar and pause on where you want to end the cut. Then, click **Segment** to set the end mark. To cancel segmentation, click **Segment** button again.



3. Click **Export > Output to AVI** button to save the wanted portion.
4. In the **Save As** dialog box, locate on where user wants to save the file, type the filename, and select the video format.

4.3.2 Playback DVR Recorded File from Hard Disk

1. Please have the hard disk which containing of recorded video data install on your PC or using external USB enclosure to connect to your PC.
2. Click **Open File** button
3. Select **DVR Recorded File(HD)** and click **OK**.
4. Select the hard disk drive from **Select Disk** window and click **OK**.

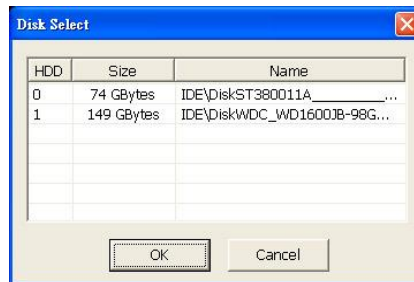

5. And then, Playback Date/Time Selection window appears. Select the date and time and click **OK**.

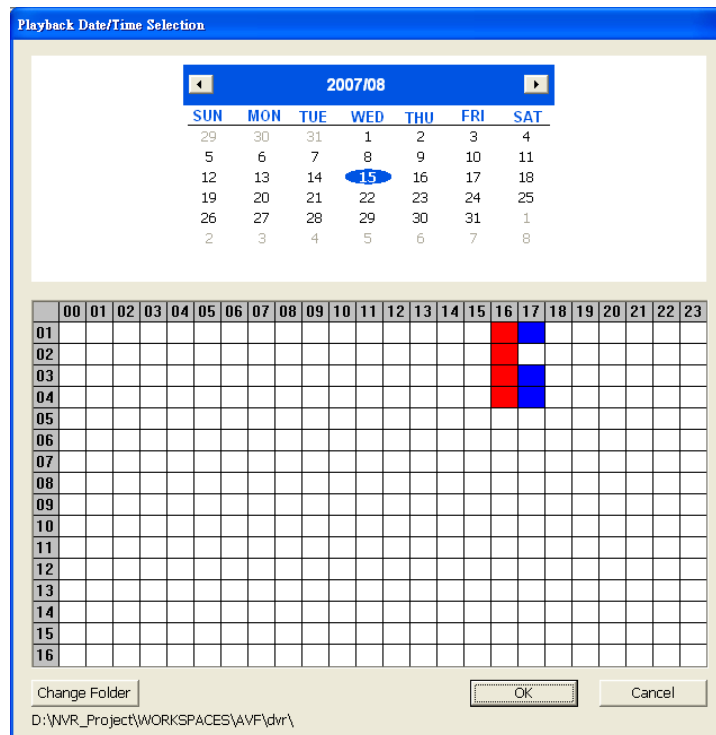

4.3.3 Playback Backup File(*.dvr)

1. Click Open File button.
2. Select **Backup File(*.dvr)** and click **OK**.
3. Select to open by date or by file.

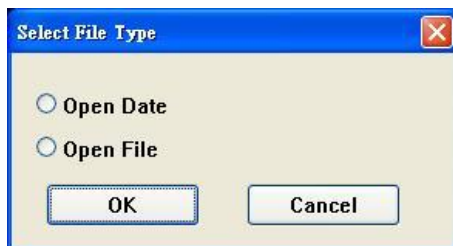

4. Open by date, located the backup file and select the date folder.
5. And then, Playback Date/Time Selection window appears. Select the date and time and click **OK**.

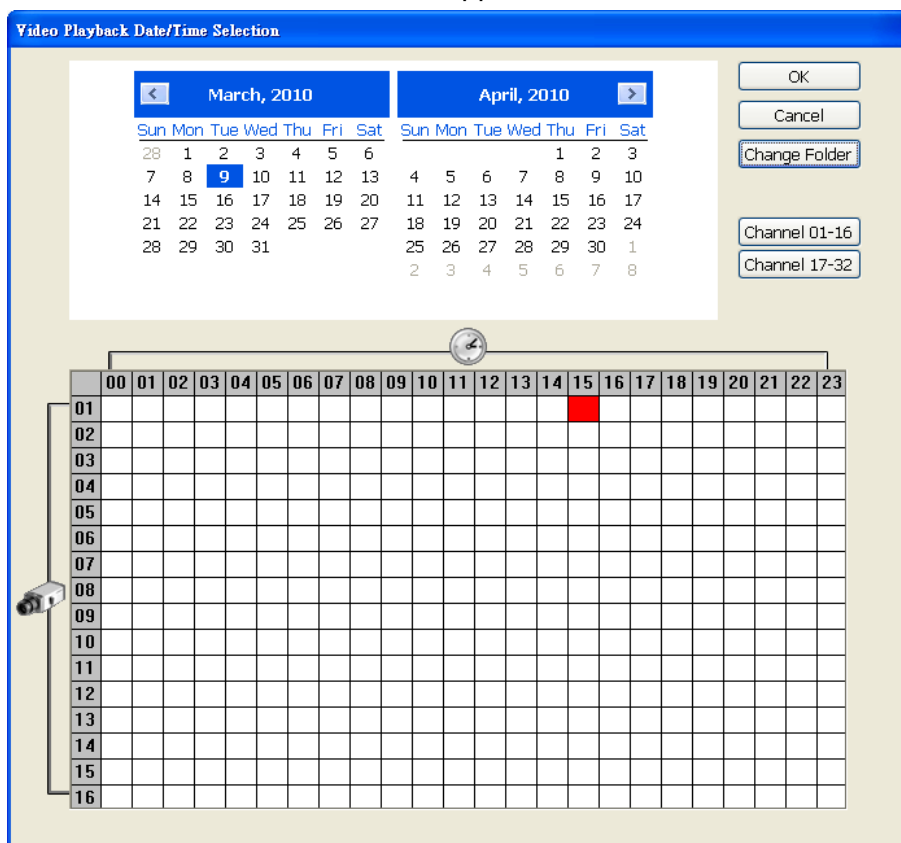

6. Open by file, located the backup file folder and click **OK**.



When open the backup video file, just locate the folder that has backup file.

4.3.4 To Backup Recorded File

HDD backup function allows user to backup recorded file from hard disk.

1. Click **Adv. Function** → **HDD Backup** on USB Playback Console UI.
2. Select the source hard disk.

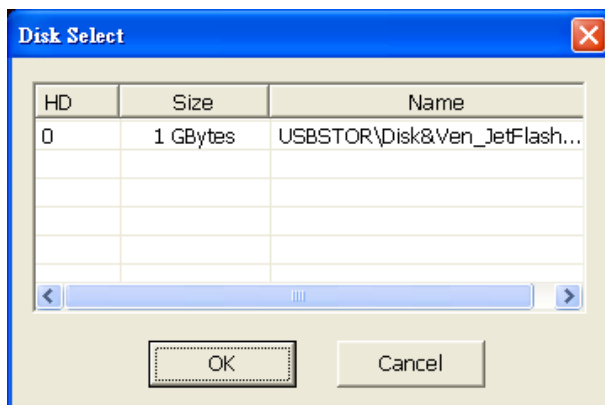

3. In Backup date/time selection windows, select the date and time. 00-24 represents hours and 01-16 represents channels. Blue block means there has recorded file. Red block means the block has been selected. Click-and-drag can select multiple block at once.

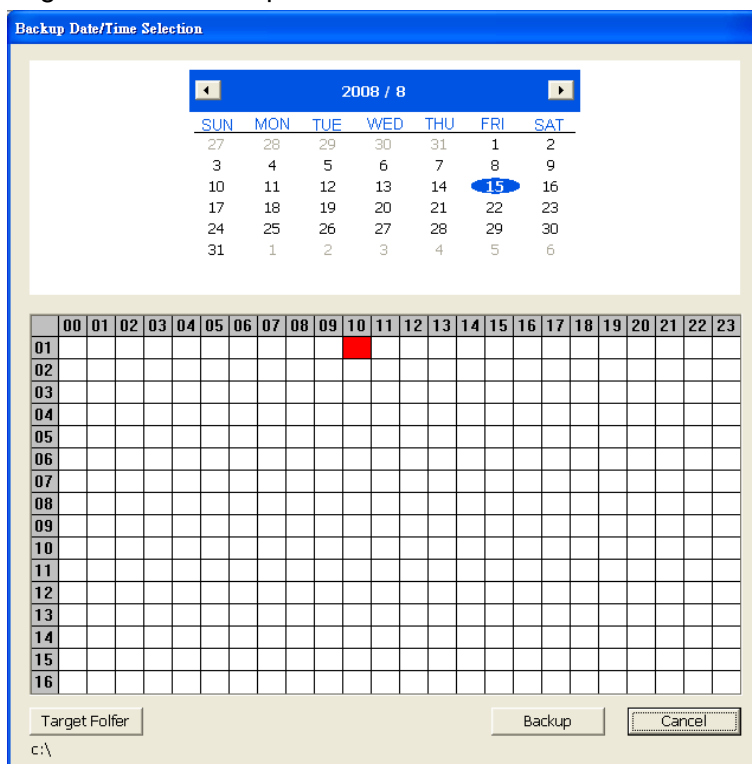



4. Click **Backup** to start backup file.
5. When backup complete, the complete information windows will display.

4.3.5 To Search Using the Visual Search

1. Click **Visual Search**.
2. In the Visual Search Setting dialog box, select the Camera number and the date. Then click **OK**.



3. When a series of frames appear by date, click on the frame to display another series of frames and search by every Hour of that date, every 3Minutes of that hour, every 10 Seconds of that minute, every Second of that 10 seconds. To go back, click . To view from the selected frame and close event search, click .

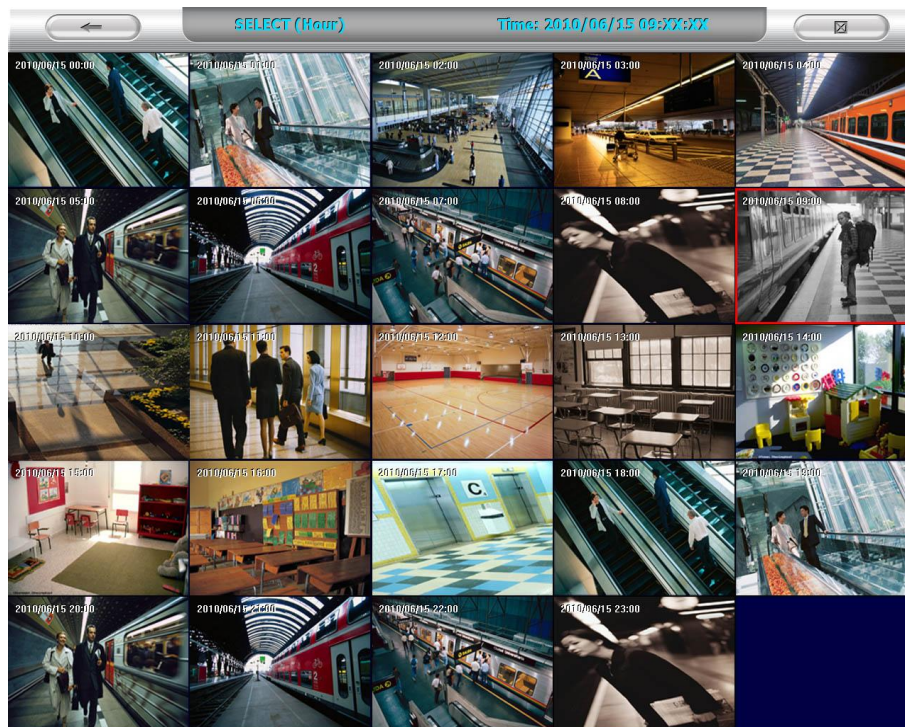

4.3.6 To Search Using the Event Search

1. Click on the video screen on where you want to search.
2. Click **Event Search**. The Event Search text (red) would appear at the lower left corner of the screen.
3. In the Event Search Setting dialog box, check the type of condition you want to search. The video search would stop at the frame that matches the condition. To keep on searching click **Find Next** () button.
4. You may also set to search and list all the result. In the **Search Duration** section, set the **Begin Time** and **End Time**. Set the **Searching Interval** time that system won't list out the same events in a period of time that user has setup. Then, click **OK** to start searching.
5. When the Event list appear, click and select the item you want to view.

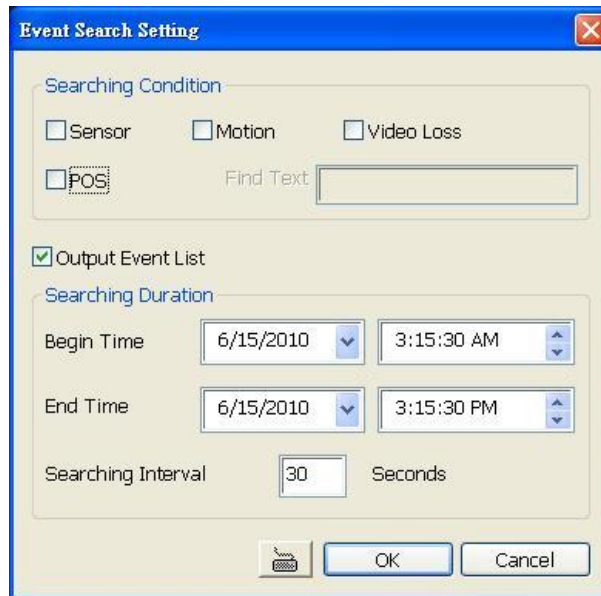

4.3.7 To Search Using the Intelligent Search

1. Click on the video screen on where you want to search.
2. Click **Intelligent Search**. The Intelligent Search text (red) would appear at the lower left corner of the screen.
3. When the Intelligent Search Setting dialog box and motion detector frame appear, you may adjust the sensitivity bar and the motion detector frame size and location. To set motion detector frame size and location, left click and drag on the screen. Then, click **OK** to start searching. The video search would stop at the frame that matches the condition. To keep on searching click . You may also set to search and list all the result. Just check the **List** box. In the **Search Duration** section set the **Begin Time** and **End Time**. Set the **Searching Interval** time that system won't list out the same events in a period of time that user has setup. Then, click **OK** to start searching.

The bundled iEnhance is a video editing tool and can only be used with *.dvr and *.avf video file. It allows you to adjust the video picture quality, segment and save the selected portion of the video, zoom in and out the image, and print or save the screen shot. You can also save the setting and apply it on other files.

To run iEnhance application, click **iEnhance** button on USB Playback Console interface.

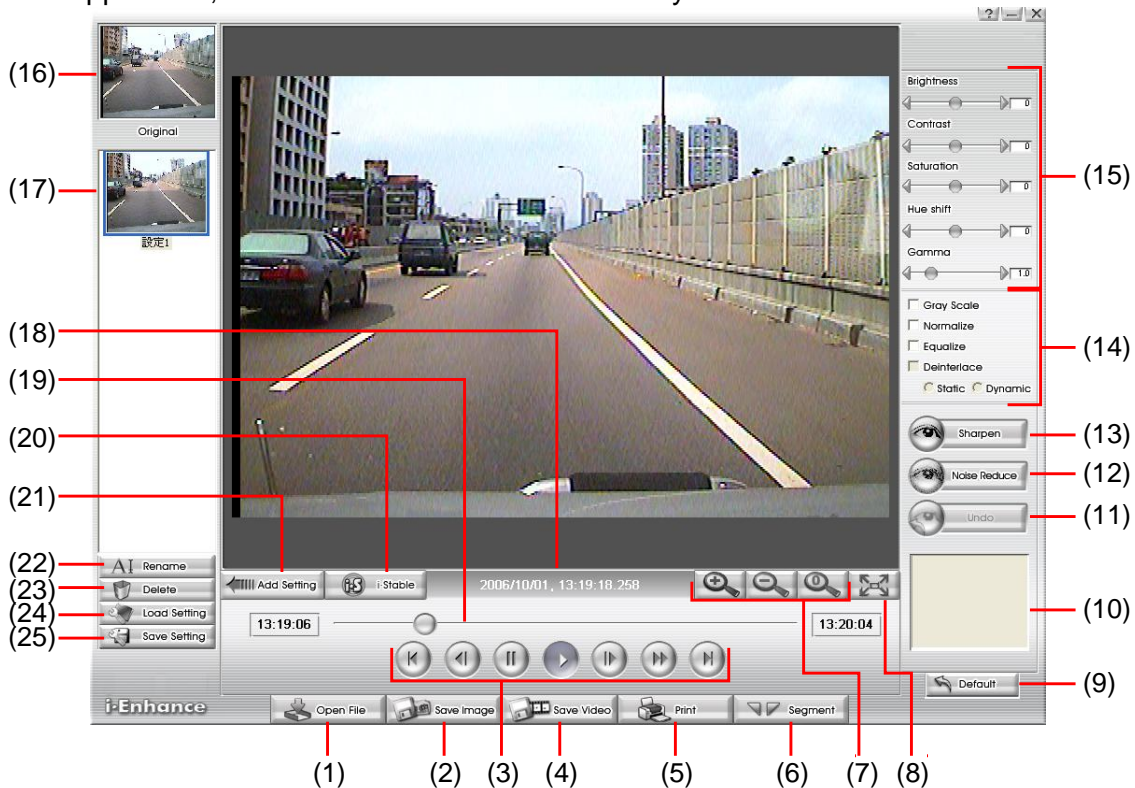

| Name | Function |
|------------------------------|---|
| (1) Open File | Access *.dvr and *.avf video file. |
| (2) Save Image | Capture and save the screen shot in *.bmp format. |
| (3) Playback Control Buttons | Begin: Move at the beginning of the video file. Previous: Go back to previous frame. Pause: Briefly stop playing the video file. Play: Play the video file. Faster: Play the video file at the faster speed. Next: Go to the next frame. End: Go to the end of the video file. |
| (4) Save Video | Save the edited or segmented video in *.avi format. |
| (5) Print | Print the screen shot. |
| (6) Segment | Mark the beginning and the end of the selected portion of the video. Two triangle marks will appear on the slider. To cancel video segmentation, click this button again. |
| (7) Zoom Buttons | Enlarge, reduce, and set the image back to normal size. |
| (8) Full Screen | Use the entire screen to only display the video. |
| (9) Default | Set the video back to original state and delete all the changes in the history box. |
| (10) History Box | List all the actions. |
| (11) Undo | Delete the last action. |
| (12) Noise Reduce | Adjust the softness and repair the damaged colors. |
| (13) Sharpness | Improve the overall image by enhancing edges. This gives the image more depth. |

| Name | Function |
|------------------------------|--|
| (14) Effects | <ul style="list-style-type: none"> ■ Gray Scale: convert the image into black and white (monochrome). ■ Normalize: adjust the brightness intensity. ■ Equalize: automatically adjust the images that are too dark. ■ De-interlace: smooth out the overlying frames. <ul style="list-style-type: none"> - Static: de-interlace for motionless scene. - Dynamic: de-interlace for moving scene. |
| (15) Picture Adjustment | Adjust the Brightness, Contrast, Saturation, Hue and Gamma. |
| (16) Original Screen | Display the original state of the image. |
| (17) Temporary Setting Block | Display the sample settings. Click the sample to apply the setting on the current video. |
| (18) Status Bar | Display the date, and time of the video. |
| (19) Progress Bar | Show the progress of the file being played. You may move the bar to seek at any location of the track. |
| (20) iStable | To reduce the jolt in the recorded video.(also see Chapter 5.1) |
| (21) Add Setting | Include the new setting to the temporary setting block. |
| (22) Rename | Change the name of the selected setting in the temporary setting block. |
| (23) Delete | Permanently remove the selected setting in the temporary setting block. |
| (24) Load Setting | Call the saved settings. |
| (25) Save Setting | Store the settings in the temporary setting block. |

5.1 To Use iStable

The iStable function can reduce the jolt in the recorded video.

1. Click **Open File** button and select the recorded video.
2. And then, click **iStable** button.
3. iStable windows will show up.
4. Select the **smoothness** level – 1(Low), 2, 3, 4, and 5(High). The default value is 3.
5. Click Play button, and then iStable function will start to initial the recorded video.
6. When the initialize is done, user will see the original and stabilized recorded video play in two windows. The original video on the right side of window and the stabilized video on the left side of window.

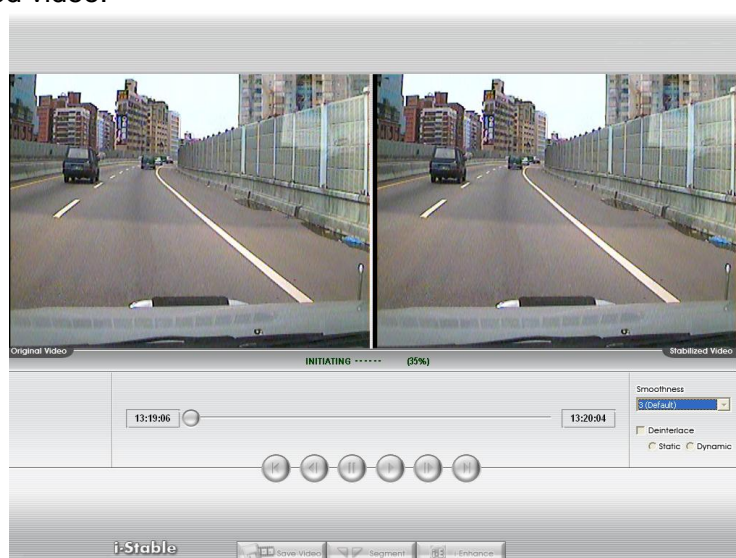

User can use Microsoft Internet Explorer to access DVR system by entering the IP address. To use this feature, make sure that your PC and DVR server both are connected to the internet and the Network feature is enabled.

Accessing this feature for the first time you will be prompted by your browser to install WebCamX.cab, allow the installation and you should be able to connect and login afterwards.

For Windows 2000, click **Yes** when the Security Warning dialog box appears.

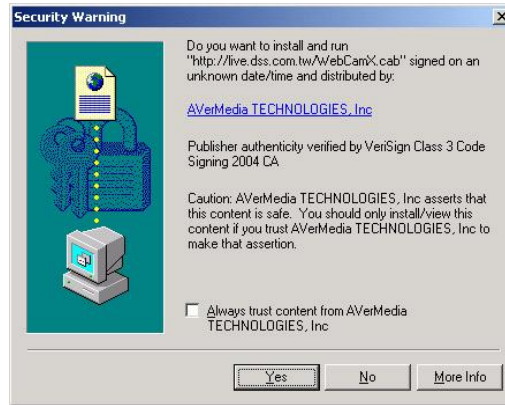

For Windows XP/Vista/7, click Install when the Internet Explorer - Security Warning dialog box appears.

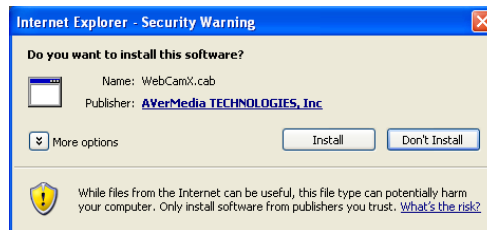

After installing the WebCamX.cab and when connecting to the DVR system, you are required to enter account ID (default is **superuser**; case sensitive) and password (default is **111111**) and select the type of network. **Superuser** account has the authority to remote setup the DVR system configuration on WebViewer. Non-superuser account only can preview the video on WebViewer and Remote Console.

i Changing account password is strongly recommended.

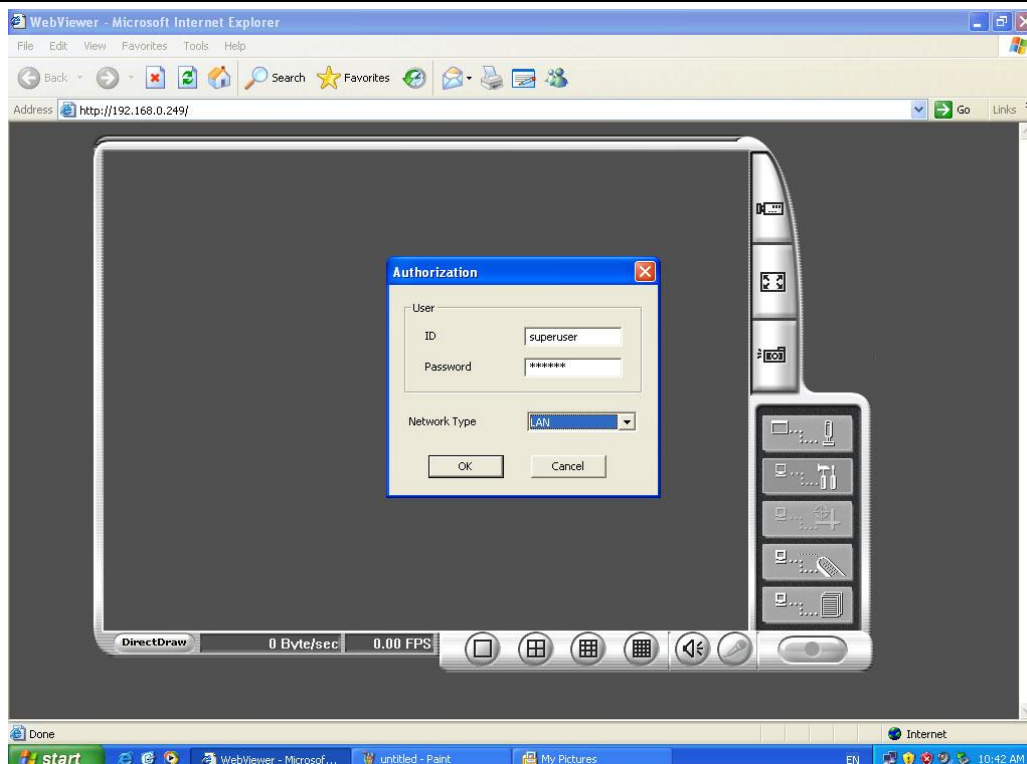

6.1 Familiarizing the Buttons in WebViewer

Right-clicking on the WebViewer video screen, enables you to start video recording, change video quality, switch camera and enable/disable DirectDraw.

i EH5108/EH5108H/EXR5008 series only has 8 channels will be available.

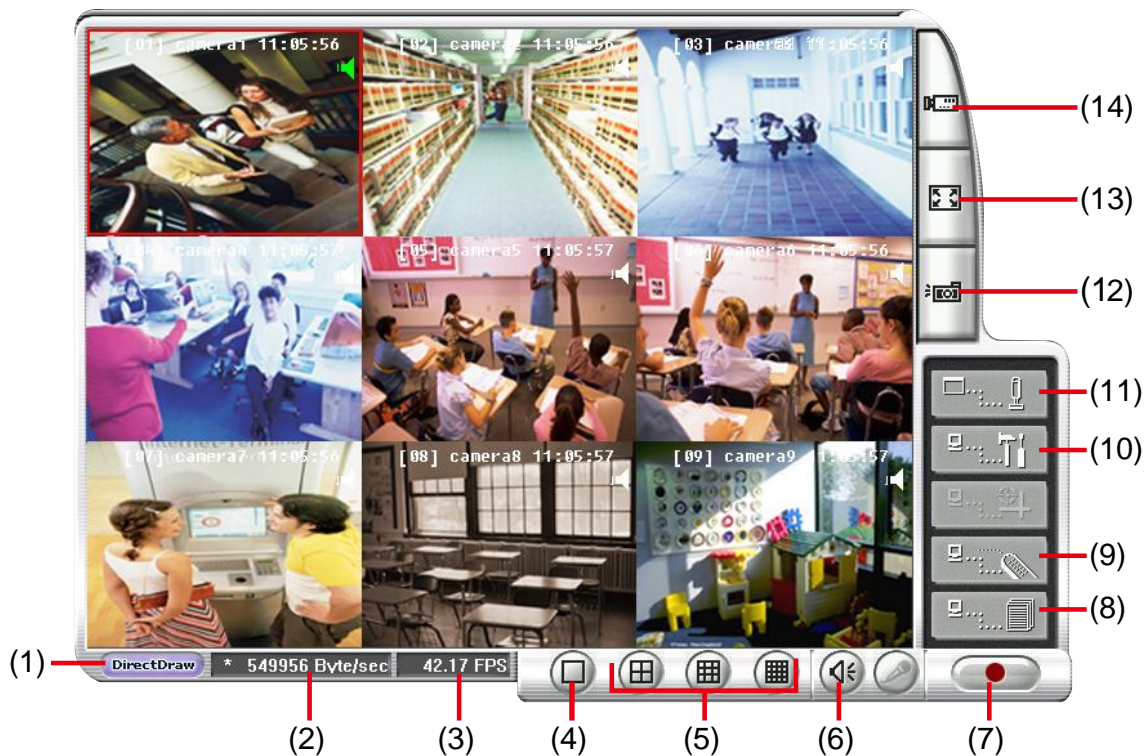

| Name | Function |
|--|---|
| (1) DirectDraw | Enhance the video quality. |
| i Not all graphic cards can support this function. If you cannot see the screen display correctly or screen is messed, please check with VGA card vendor. | |
| (2) Received file size | Indicate the size of the data being sent per second. |
| (3) Camera frames | Indicate the number of frames per second. |
| (4) One screen view | To view single camera view on screen. User can right click on the screen to switch to different camera view. |
| (5) Split screen view | To view all cameras on screen simultaneously. |
| (6) Audio | Enable/disable remote sound. |
| (7) Record | Start to record the video of the selected camera in AVI format. Directly click screen to select the channel that user wants to record and press Record button. |
| (8) Remote Console | Initiate Remote Console. It allows you to control DVR server (see also Chapter 6.3). |
| (9) Event Log Viewer | Display the Event logs, Operation logs, System logs, and Network logs. |
| (10) Remote setup | Change the DVR server settings (see also Chapter 6.1.1) |
| (11) PTZ Control | Initiate PTZ camera controller(see also Chapter 6.2) |
| (12) Snapshot | Capture and save the screen shot in *.bmp format. |
| (13) Full screen | Use the entire area of the screen to only display the video. To return, Right click the mouse or press ESC on the keyboard. |

Name**Function**

(14) Select cameras to view

Select to the view camera from different server. In Select Camera dialog box, Display column, click to enable/disable viewing the camera.

Click **Add Server** and select the server type between DVR and IP Cam to add.

Click **Delete Server** to delete the selected item.

Click **Import** to load the previous saved list.

Click **Export** to save the list.

Click **Apply All** to change all the camera video quality based on the selected setting.

Click **OK** to exit.

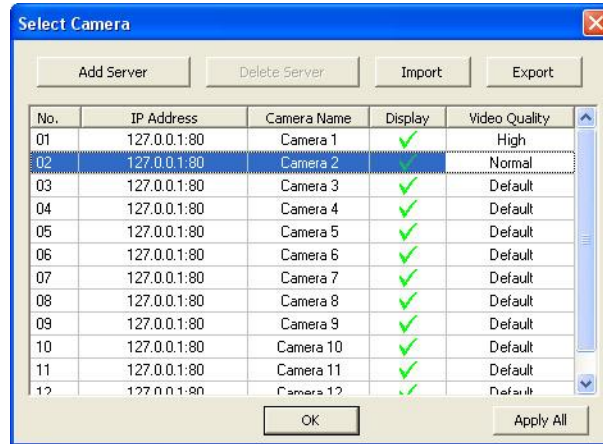

EH5108/EH5108H/EXR5008 series only has 8 channels will be available.

6.1.1 To Setup Remote System Setting

The setting here applies to Remote DVR only.

6.1.1.1 System Setting

In the System Setting windows, click **Update** to accept the new settings, click **Exit** to exit without saving, and click **Default** to revert back to original factory setting.

The screenshot shows the 'System Setting' window with the following sections and settings:

- Storage Path:** A table with columns: Disk Name, Free Space, Capacity, Status. One entry: SATA-0:WD3200AVVS-63L2B, Normal.
- Delete recorded data after:** (1) (unchecked), 7 Days.
- Delete event and alarm log after:** (2) (checked), 30 Days.
- Overwrite Enable:** (3) (checked).
- Miscellaneous:** (4) Playback Mode: Play the last file; Date Format: mm/dd/yyyy; AutoScan Period: 3 Sec.
- Login:** (5) Auto Login after system boot up; Auto Record after system boot up; Auto start Network after system boot up; Default User: superuser.
- Language:** System Language: Japanese.
- Configuration:** Import, Export buttons.
- POS:** Setting button.
- Video Standard:** NTSC (selected), PAL.
- Touch Monitor:** Connect, Adjust buttons.
- Date and Time Setting:** System Date and Time: 09/22/2009 15:24:05; Start Date/Time: 2009/01/02 04:20; End Date/Time: 2009/01/02 04:20; Daylight Bias: 00:00.
- Firmware:** Product Version: X8.01.21.00.00; IPCam Module.

Buttons at the bottom: Default, Update, Exit.

(1) Delete recorded data after

If you want the system to automatically erase the data after a certain days, enable the **Delete recorded data after** check box and enter the numbers of days in **Days** text box.

(2) Delete event and alarm log after

If you want the system to automatically erase the event and alarm log files after a certain days, enable the **Delete event and alarm log after** check box and enter the numbers of days in **Days** text box.

(3) Overwrite Enable

When there is not enough free space to record one hour data, the system automatically replaces the oldest data.

(4) Miscellaneous

Enable the conditions in **Miscellaneous** section you want the system to perform.

- Playback Mode

Select the mode of playback the video.

- **Select date and time:** Select the date and time which user wants to playback.
- **Play the last file:** Automatically playback the video from the last hour
- **Instant Playback:** Automatically playback the video which has just recorded

- Date Format

Select the date format which wants to display in **Select date and time** playback mode

- Auto Scan Period

Set the time gap of the Auto Scan function from 3 to 10 seconds. This automatically switches to the next video in cycle depending on the set time gap.

(5) Login

Enable the conditions in Login section you want the system to automatically carry out.

- **Auto record when login**

Automatically start video recording when the DVR is executed.

- **Auto start Network when login**

Automatically connect to network when the DVR is executed.

6.1.1.2 Camera Setting

Select the camera from remote DVR servers to modify settings. In the Camera Setting windows, click **Update** to save and apply the new settings, click **Exit** to exit without saving.

IP Camera Setting



EH5108/EH5108H/EXR5008 series only has 8 channels will be available.

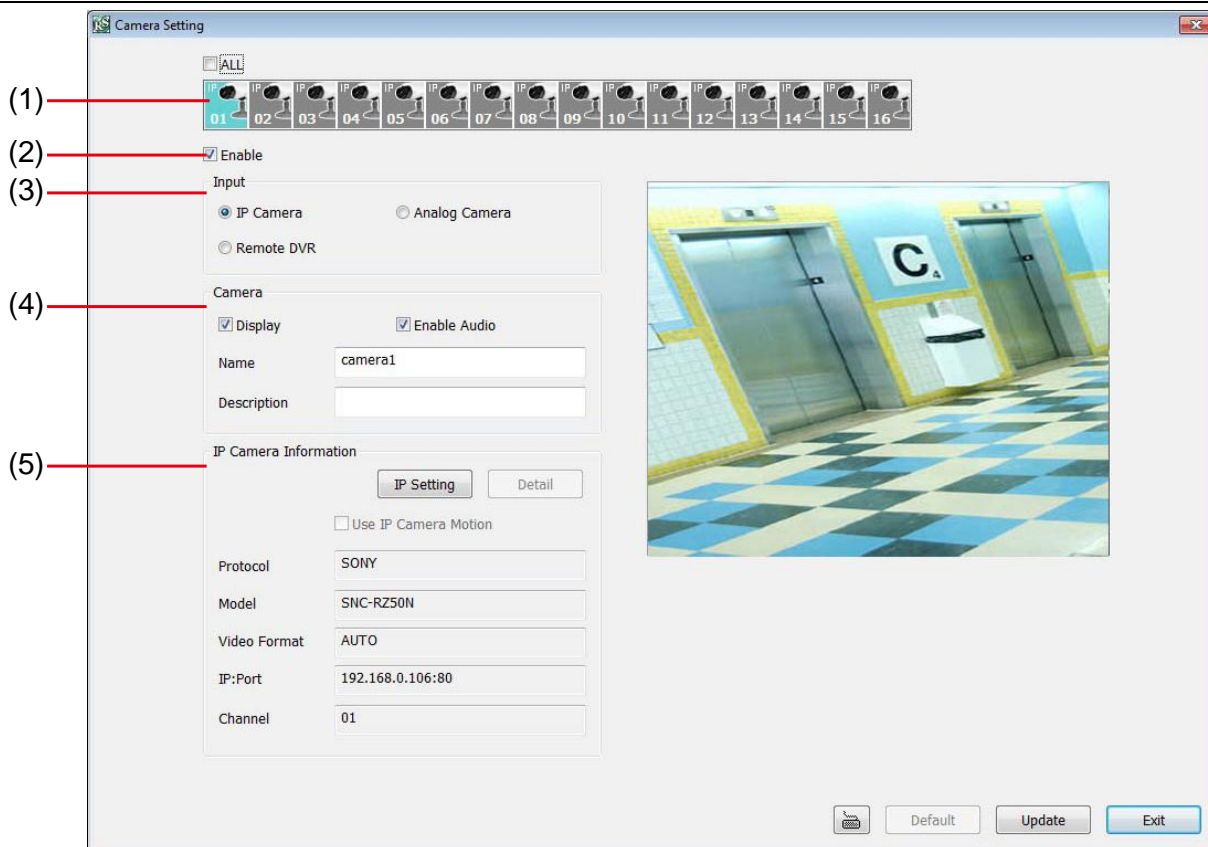

(1) Camera Icons

Select the camera number you want to adjust the video setting. To select all the cameras, enable the **ALL** check box. To select more than one camera, Right click on the camera icon. To select one camera only, Left click on the camera icon. The camera icon turns red when it is selected.

(2) Enable

Set to enable/disable the selected camera. When there is no video source on the camera, we suggest disabling it so that the system won't detect it as video loss error.

(3) Input

Select the type of camera as IP camera. For General camera setting, see [Analog Camera Setting](#). To modify camera of remote DVR, see [Remote DVR Camera Setting](#).

(4) Camera

- Display

Enable/disable to show the video. Even if the video of the selected camera is hidden you can still record the video and preview it in playback mode.

- Enable Audio

Enable/disable audio of the camera.

- Name

Change the camera name

- Description

Add a short comment

(5) IP Camera Information

To setup IP camera and display current IP camera information.

- **IP Setting:** Click **IP setting** to add the IP camera.

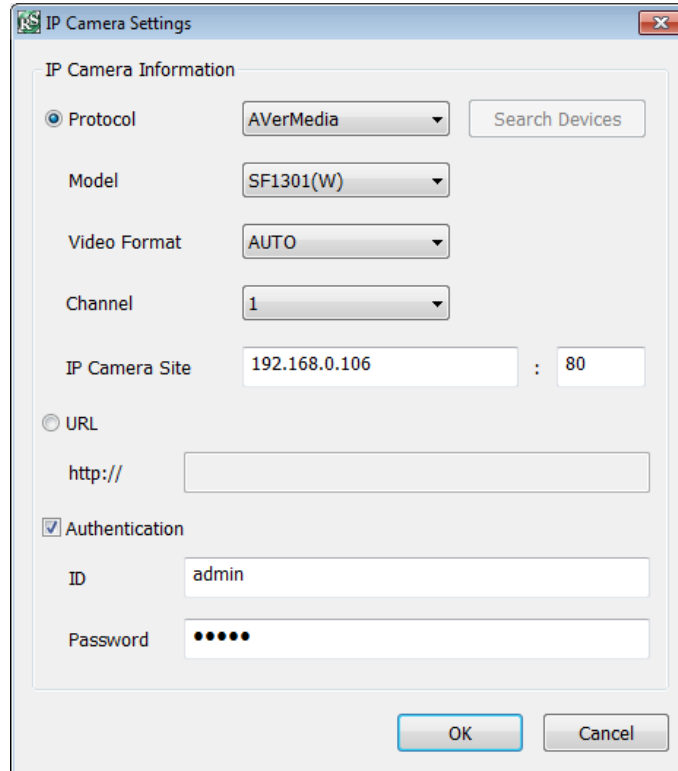

The screenshot shows the 'IP Camera Settings' dialog box. It is divided into several sections:

- IP Camera Information:** Contains a 'Protocol' dropdown menu set to 'AVerMedia', a 'Model' dropdown menu set to 'SF1301(W)', a 'Video Format' dropdown menu set to 'AUTO', and a 'Channel' dropdown menu set to '1'. Below these is the 'IP Camera Site' field, which is split into two parts: the first part contains the IP address '192.168.0.106' and the second part contains the port number '80'. To the right of the 'Protocol' dropdown is a 'Search Devices' button.
- URL:** Contains a radio button and a text field starting with 'http://'.
- Authentication:** Contains a checked checkbox, an 'ID' text field with the value 'admin', and a 'Password' text field with five dots.

At the bottom of the dialog are 'OK' and 'Cancel' buttons.

1. Click the radio button of **Protocol** to start setup IP camera.
2. Select the **Protocol**, **Model**, **Video Format**, and **Channel** of the IP camera.
3. Enter IP address and connecting port in **IP Camera Site** column.
4. Also, user can enter URL of IP camera instead of IP address.
5. If the IP camera has authority request, please enable **Authentication** and enter **ID** and **Password**.
6. Click **OK** to connect with the IP camera.

Analog Camera Setting

Select the camera from remote DVR servers to modify settings. In the Camera Setting windows, click **Update** to save and apply the new settings, click **Exit** to exit without saving.



EH5108/EH5108H/EXR5008 series only has 8 channels will be available.

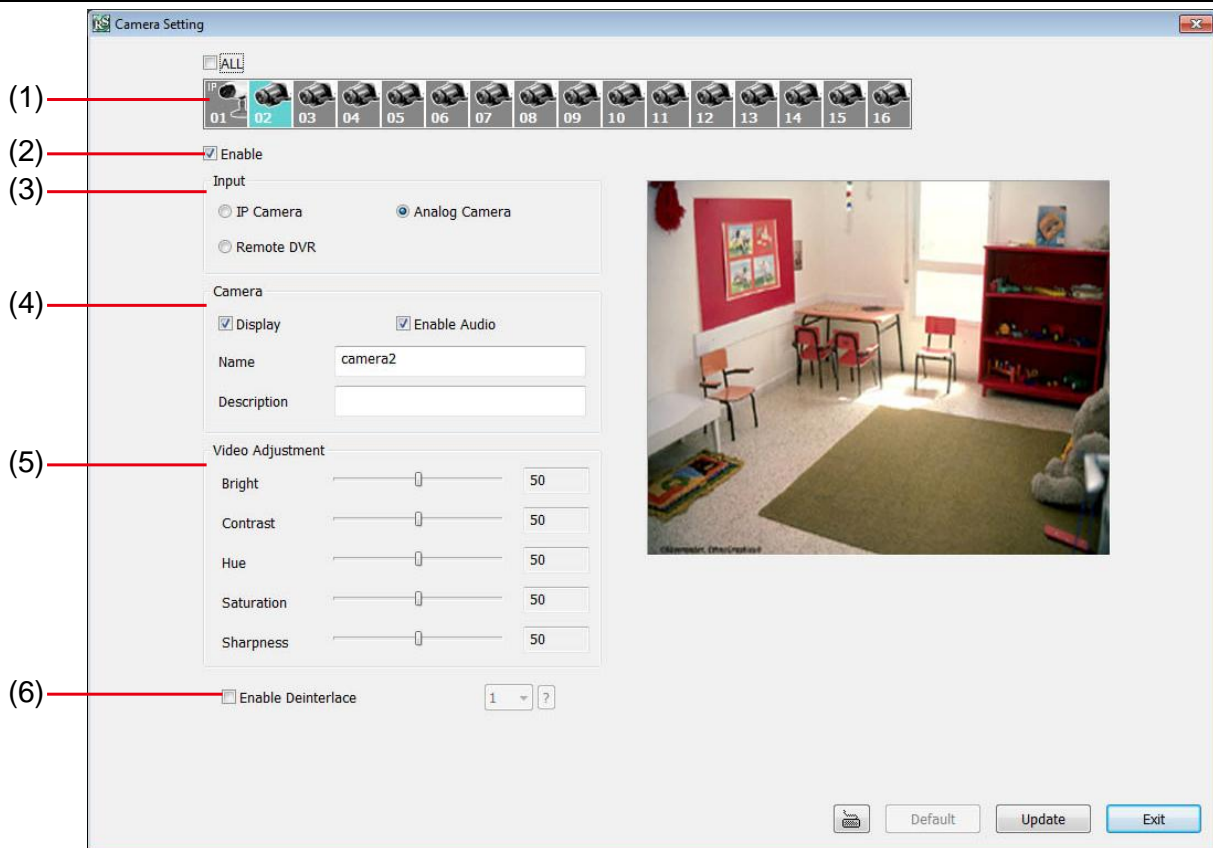

(1) Camera Icons

Select the camera number you want to view. To enable/disable all cameras, click **ALL** check box.

(2) Enable

Set to enable/disable the selected camera. When there is no video source on the camera, we suggest disabling it so that the system won't detect it as video loss error.

(3) Input

Select the camera type as **General Camera**. For IP camera setting, see [IP Camera Setting](#). To modify camera of remote DVR, see [Remote DVR Camera Setting](#).

(4) Camera

- Display

Enable/disable to show the video. Even if the video of the selected camera is hidden you can still record the video and preview it in playback mode.

- Enable Audio

Enable/disable audio of the camera.

- Name

Change the camera name

- Description

Add a short comment

(5) Video Adjustment

Adjust the Brightness, Contrast, Hue and Saturation of the camera.

(6) Enable Deinterlace

Enhance the video quality. Set the **Enable Deinterlace** mode to #1, if you are capturing motionless picture and #2, if it captures lots of movement.

Remote DVR Camera Setting

Select the camera to modify settings. In the Camera Setting windows, click **Update** to save and apply the new settings, click **Exit** to exit without saving.



EH5108/EH5108H/EXR5008 series only has 8 channels will be available.

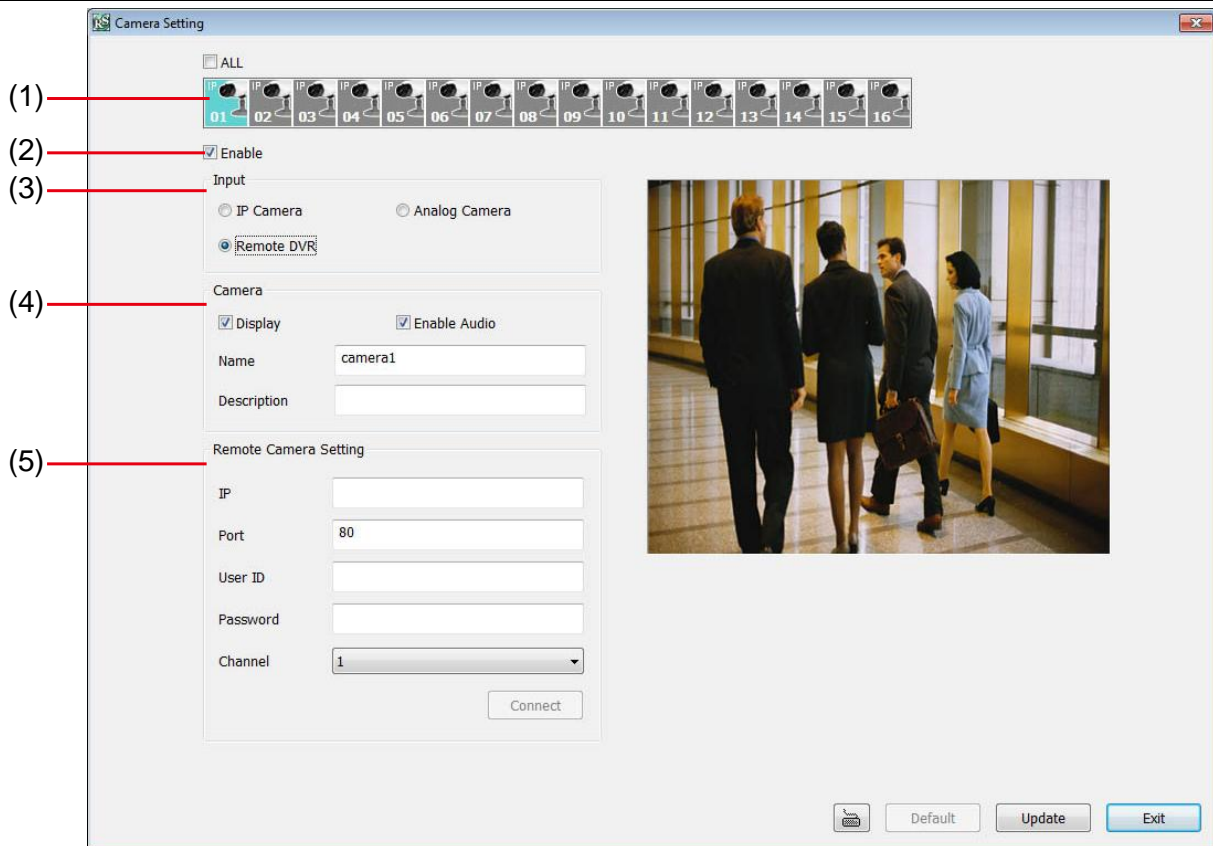

(1) Camera Icons

Select the camera number you want to view. To enable/disable all cameras, click **ALL** check box.

(2) Enable

Set to enable/disable the selected camera. When there is no video source on the camera, we suggest disabling it so that the system won't detect it as video loss error.

(3) Input

Select the camera type as **Remote DVR**. For IP camera setting, see [IP Camera Setting](#). To modify analog camera setting, see [Analog Camera Setting](#).

(4) Camera

- **Display**
Enable/disable to show the video. Even if the video of the selected camera is hidden you can still record the video and preview it in playback mode.
- **Enable Audio**
Enable/disable audio of the camera.
- **Name**
Change the camera name
- **Description**
Add a short comment
- **IP**
Enter the IP address of the camera
- **Port**
The port for connection
- **User ID**

- Enter the user id that for connecting authority
- **Password**
Enter the password that is for connecting authority
- **Channel**
Select the channel of connected camera

6.1.1.3 Record Setting

In the Recording setup windows, click **OK** to accept the new settings, click **Exit** to exit without saving, and click **Default** to revert back to original factory setting.

Record Setting of IP Camera



EH5108/EH5108H/EXR5008 series only has 8 channels will be available.

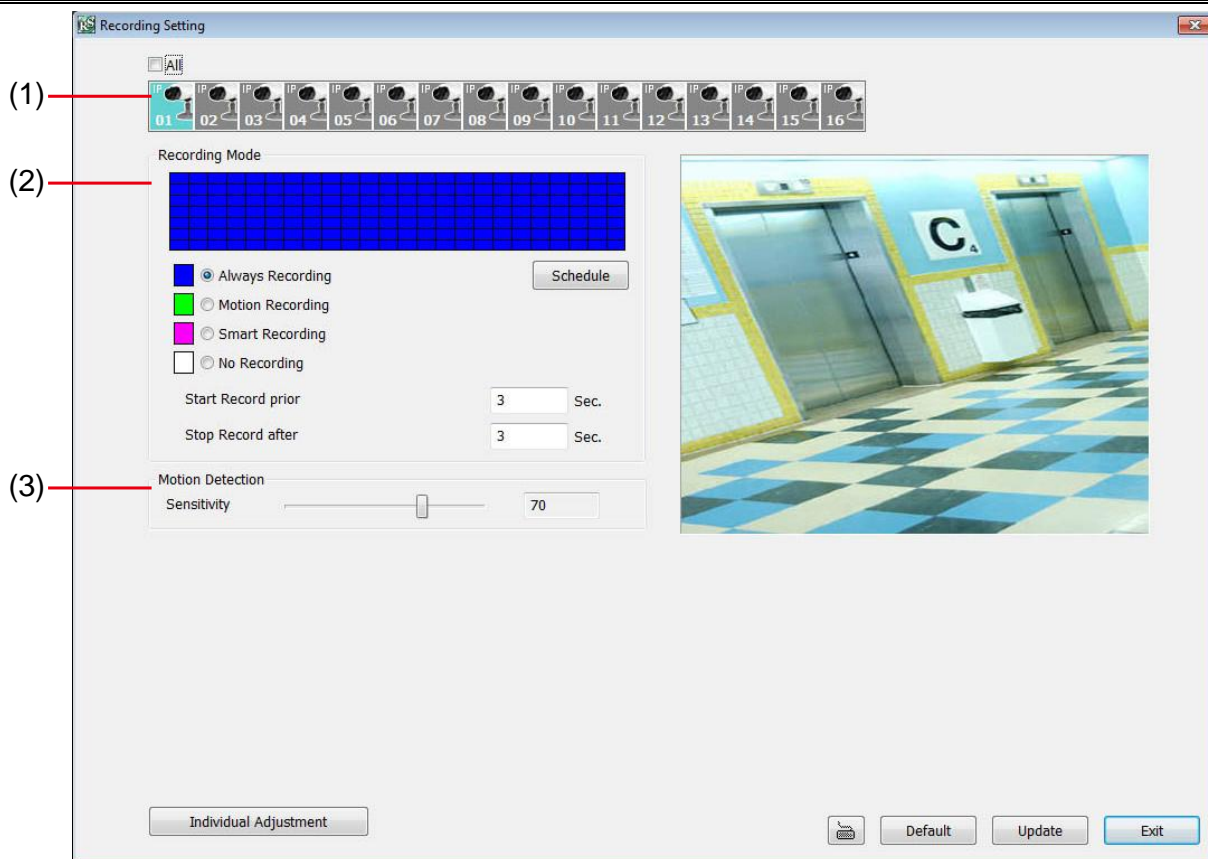

(1) Camera Icons

Select the camera number you want to set the recording setting. To select all the cameras, enable the **ALL** check box. To select more than one camera, **Right click** on the camera icon. To select one camera only, **Left click** on the camera icon. The camera icon turns red when it is selected.

(2) Recording Mode

The horizontal blocks from 00 to 23 represent the time in 24-hour clock and the vertical block 1 to 7 represent the day in the week block (Sunday to Saturday). To record in full 24 hours and 7 days a week, select the recording mode and click the **☉** button. If you want to only record at a particular time or day, click **Schedule** button and select the **Recording Mode**, and then click on the time or day blocks. When the system starts recording a red triangle mark would appear at the upper left corner of the screen. The recording modes are listed below:

- **Always Recording**

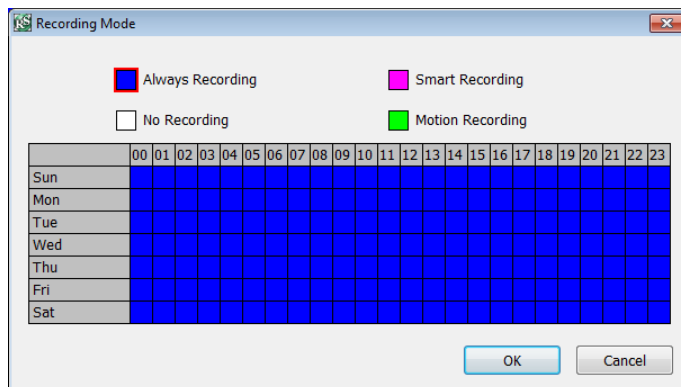

Record the video from the selected camera and save it to the designated storage path

- **Motion Recording**

Start recording the video from the selected camera only when the system detects movement. Once a motion is detected, the system automatically saves the previous frames and stop based on the **Start Record Prior** and **Stop Record After** settings.

- **Smart Recording**

Automatically switch to recorded at the maximum frame rate setting once a motion is detected and if there is no motion, it records at the minimum frame rate setting.

- **No Recording**

The system won't do any recording.

(3) Motion Detection

Adjust the sensitivity of the motion detection. The higher the value, the finer the sensitivity is detected. When it detects a motion, a green triangle mark would appear at the upper left corner of the screen.

Record Setting of Analog Camera



EH5108/EH5108H/EXR5008 series only has 8 channels will be available.

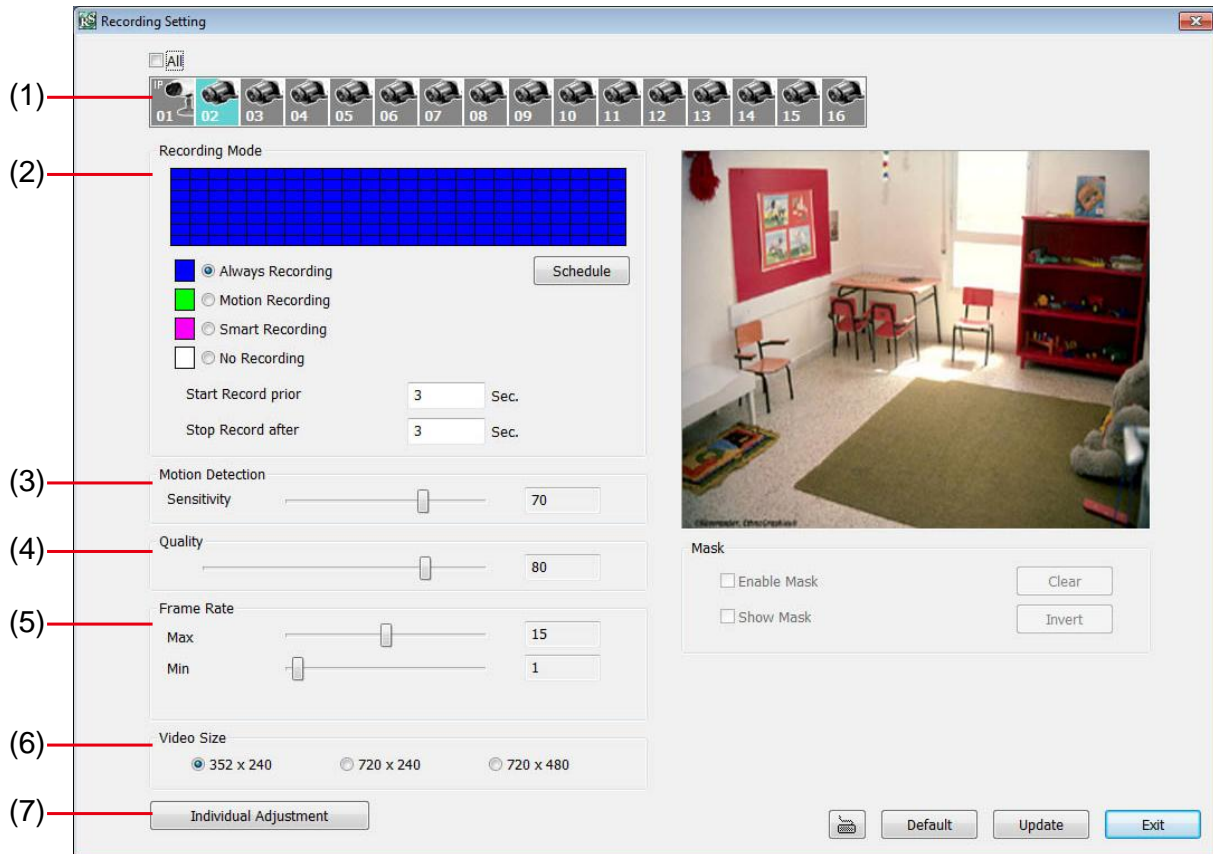

(1) Camera Icons

Select the camera number you want to set the recording setting. To select all the cameras, enable the **ALL** check box. To select more than one camera, **Right click** on the camera icon. To select one camera only, **Left click** on the camera icon. The camera icon turns purple when it is selected.

(2) Recording Mode

The horizontal blocks from 00 to 23 represent the time in 24-hour clock and the vertical block 1 to 7 represent the day in the week block (Sunday to Saturday). To record in full 24 hours and 7 days a week, select the recording mode and click the **☉** button. If you want to only record at a particular time or day, click **Schedule** button and select the **Recording Mode**, and then click on the time or day blocks. When the system starts recording a red triangle mark would appear at the upper left corner of the screen.

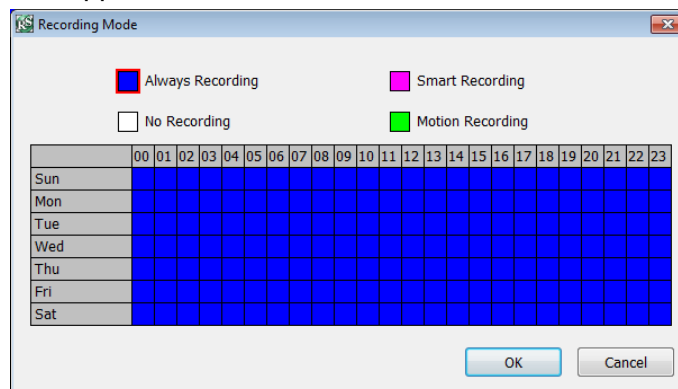

The recording modes are listed below:

- Always Recording

Record the video from the selected camera and save it to the designated storage path

- Motion Recording

Start recording the video from the selected camera only when the system detects movement. Once a motion is detected, the system automatically saves the previous frames and stop based on the **Start Record Prior** and

Stop Record After settings.

- **Smart Recording**

Automatically switch to recorded at the maximum frame rate setting once a motion is detected and if there is no motion, it records at the minimum frame rate setting.

- **No Recording**

The system won't do any recording.

(3) Motion Detection

Adjust the sensitivity of the motion detection. The higher the value, the finer the sensitivity is detected. When it detects a motion, a green triangle mark would appear at the upper left corner of the screen.

(4) Quality

Adjust the video quality. The higher the value, the lower the compression level and uses more hard disk space.

(5) Frame Rate

Set the maximum and minimum number of frames to be recorded during motion and motionless state. The frame rate ranges from 01 to 30 for NTSC and 01 to 25 for PAL. The higher the frame rate, it uses more hard disk space.

i Always recoding frame rate is depending on max frame rate value.

(6) Video Size

Select the size of the video and click the  button. The higher the size, the larger the file it create.

(7) Individual Adjustment

Each camera can adjust video size and frame rate individually. Click **Default** will back to the factory default value. The frame rate usage is shown in **Used** and **Unused** columns by CIF mode.

- i**
- Only analog camera can adjust video size and frame rate by channel.
 - EH5108/EH5108H/EXR5008 series only has 8 channels will be available.
-

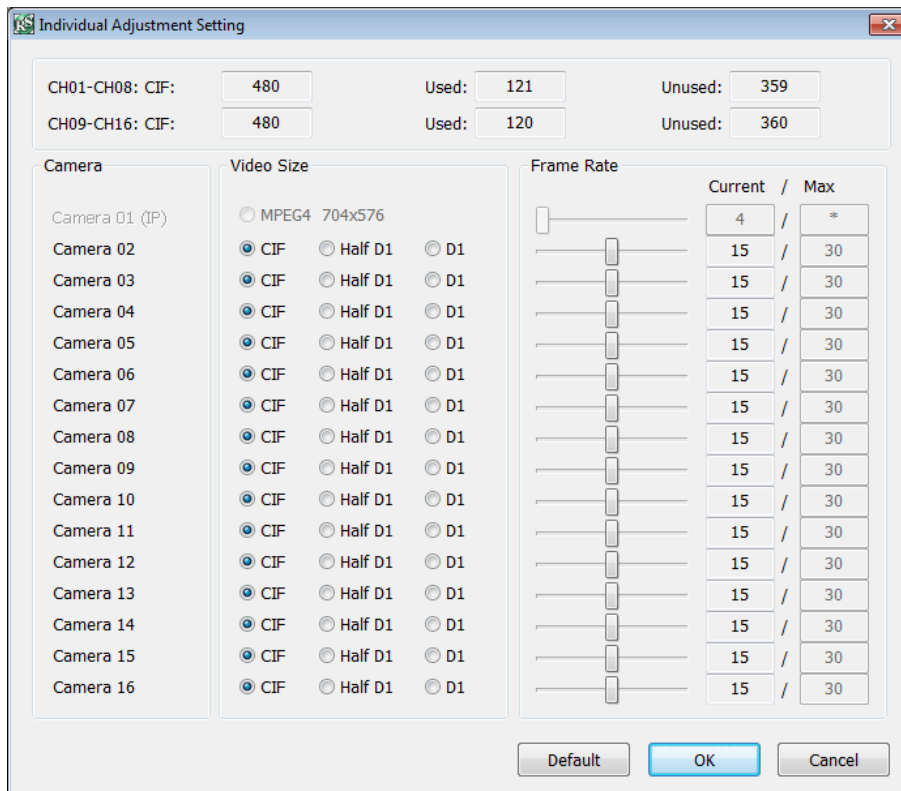

6.1.1.2 Network Setting

In the Network Setting dialog box, click **Update** to accept the new settings, click **Exit** to exit without saving, and click **Default** to revert back to original factory setting. For the network service ports that use by DVR server, please see [Appendix A](#).

The screenshot shows the 'Network Setting' dialog box with the following sections and callouts:

- (1) Server Name: AMH-S161
- (2) Transmitting Cameras: All checked, 1-16 checked.
- Main Configuration: Server IP: 192.168.1.146, Remote Console PORT: 5550
- Remote Update Configuration: PORT: 5005
- WebViewer Configuration: Enable Anonymous Login: unchecked, WebViewer PORT: 80
- Network Time Synchronization: Time Server: (empty), Time Zone: GMT+00:00, Automatic synchronize at: 00:00
- Other Configuration: Enable White List: checked, Network Bandwidth Limit: checked

Buttons at the bottom: Default, Update, Exit.

(1) Server Name

Assign a name for the DVR unit. Alphabet letters and numbers only.

(2) Transmitting Cameras

Select and click on the camera number in the Transmitting Camera section you want to make it accessible via internet using WebViewer, Remote Console, PDA Viewer and JAVAViewer (still image). To select all the cameras, enable the **ALL** check box.



EH5108/EH5108H/EXR5008 series only has 8 channels will be available.

(3) Network Time Synchronization

Adjust the DVR system time same as network time server. Fill in the **Time Server** IP address or domain name. Select the **Time Zone** that DVR is located. And then, mark the **Automatic Synchronize** time to set automatic synchronize time on a daily basis.

(4) Other Configuration

- Enable White List

An access permit list for the remote accessing of DVR server. Enter the IP address and click **Add**. Or, enter a range of IP address and click **Add**. To delete the IP from the list, select the IP and click **Delete** button. To reset the input, click **Clear** button.

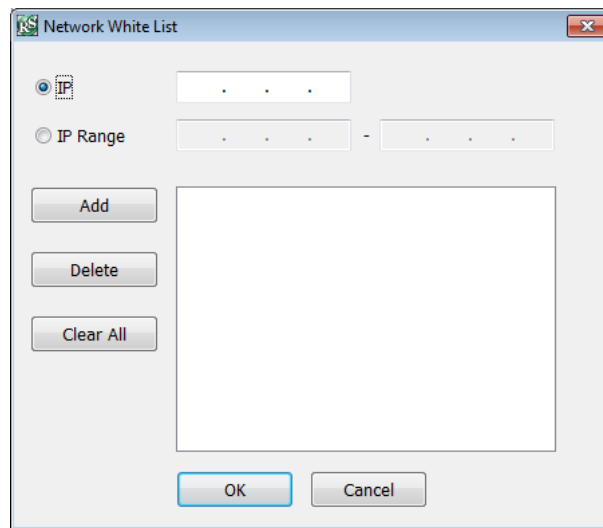

- **Network Bandwidth Limit**

By Channel: Set the network bandwidth by each channel.

All: Set the total network bandwidth consumption limit.

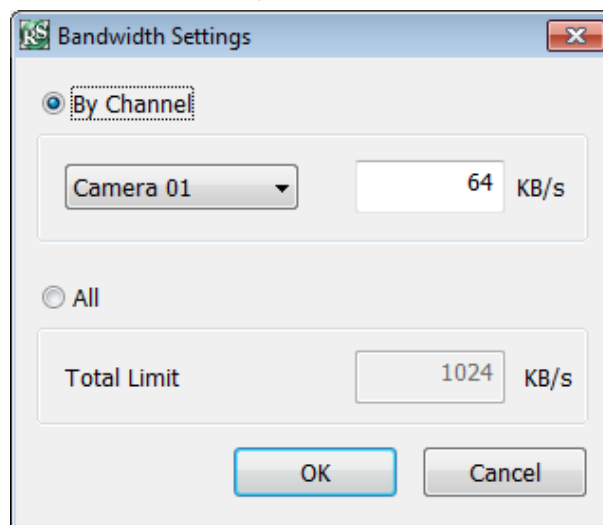

6.1.1.3 Alarm Setting

In the Alarm Setting dialog box, click **Add** to insert and set new alarm setting, click **Delete** to remove the selected alarm setting, click **Update** to save the setting, **Exit** to exit without saving, and **Default** to revert back to original factory setting.

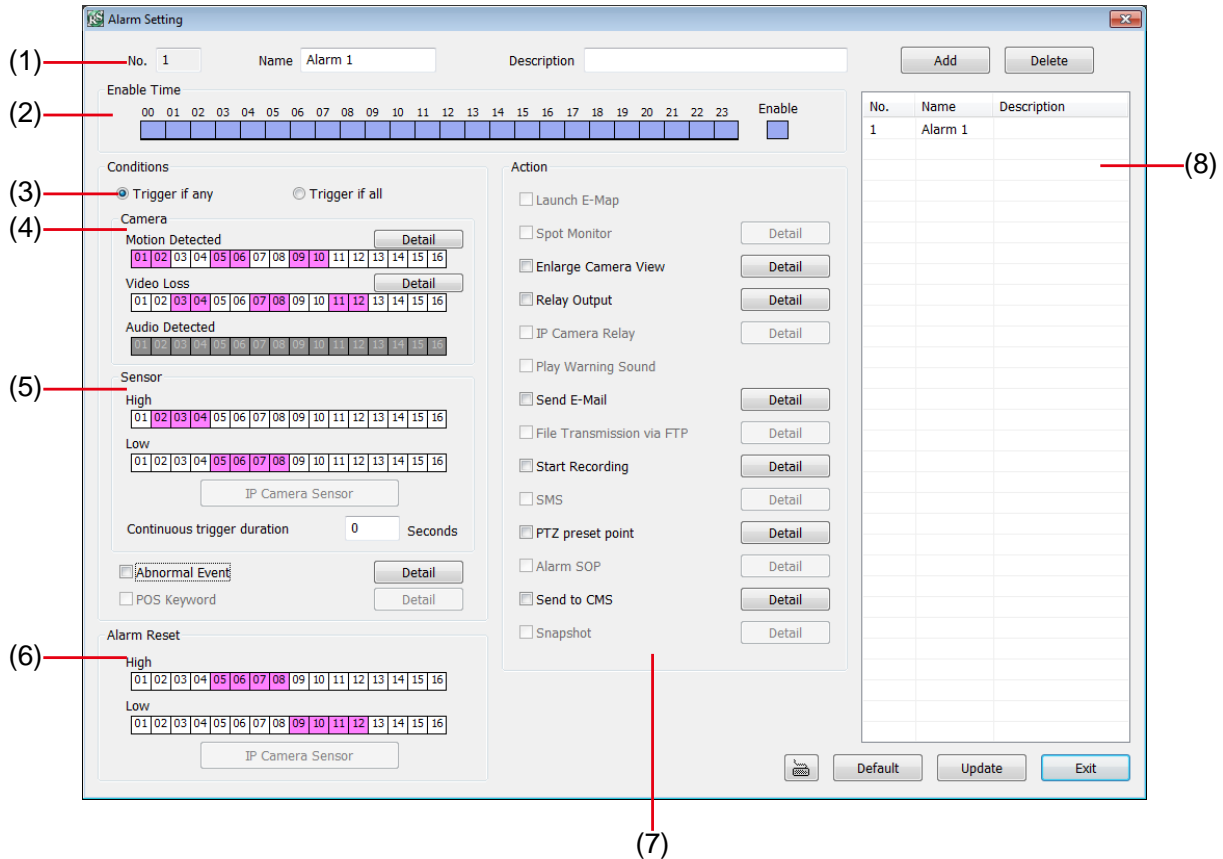

1. Click **Add** to insert and set a new alarm setting. Click the items in the **(8) Alarm Setting List** if you want to modify the alarm setting.
2. In **(1) No./Name/Description** enter alarm name and description. Alarm **No.** will be created by DVR system.
3. In **(2) Enable Time**, the number from 00 to 23 represent the time in 24-hour clock. Select the time and click the block you want to activate or deactivate the alarm function. When it is deactivated the color of the block turns white.
4. In **(3) Conditions**, you can set **“Trigger if any”** to activate if it falls to one of the conditions or **“Trigger if all”** to activate if it falls to all conditions.
5. In **(4) Camera** section, select and click on the camera number (01 to 16) in **Motion Detected** and **Video Loss** to set the condition for the system to alarm.
 - **Motion Detected:** Click on the camera number to the motion condition for the system to alarm. Click **Detail** to setup the system to send out the alarm when motion has been detected to last the time that user has entered in **Continuous trigger duration**.

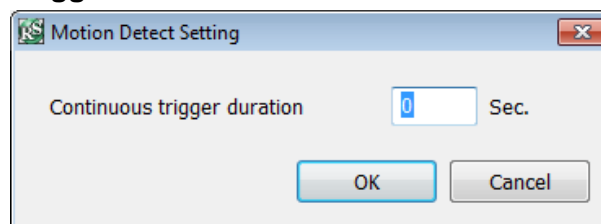

- **Video Loss:** Click the camera number to set the alarm condition when video is lost. Click the **Detail** to setup the system to send out the alarm when video has been lost to last the time that user has entered in **Continuous trigger duration**.

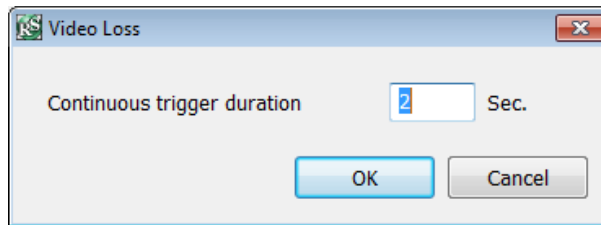

6. In **(5) Sensor**, select and click on the sensor number to set the condition for the system to alarm. If the sensor normal status is high, set the sensor condition to low.
- Enable/disable the **Abnormal Event** check box, to set the condition of the event for system to alarm.

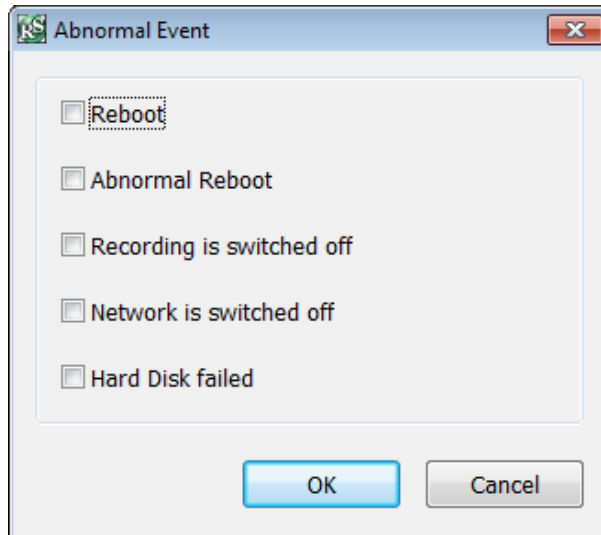

- **Reboot:** when the DVR system reboot without abnormal condition, the system will send out the alarm message.
 - **Abnormal Reboot:** when the DVR system reboot in irregular condition, the system will send out the alarm message.
 - **Recording is switched off:** when the recording has been stopped, the system will send out the alarm message.
 - **Network is switched off:** when the network connection of DVR system is lost, the system will send out the alarm message.
 - **Hard Disk failed:** when the hard disk doesn't work normally, the system will send out the alarm message.
- **Continue trigger duration:** Set a time period that when sensor has been trigger and stay in the same status for that period, then the alarm will be sent out.
7. In **(6) Alarm Reset**, click the camera number to set the reset condition of alarm. Once alarm is reset, all alarm action will stop at the moment. If the sensor normal status is high, set the alarm reset condition to low.
8. In **(7) Action**, you may now set the alarm action for the system to perform when the alarm condition is activated.

- **Enlarge Camera View**

Switch to only display video in Preview mode from where the alarm is activated.

- a. Select the camera from drop down list to specify which camera video to be enlarged on screen when the alarm is triggered.
- b. **Retrieve time:** set the waiting duration before system switching back to original Preview mode. If the retrieve time is un-mark, the alarm video will keep enlarging until user switch back to Preview mode manually. The retrieve time range is 0~ 600 seconds.

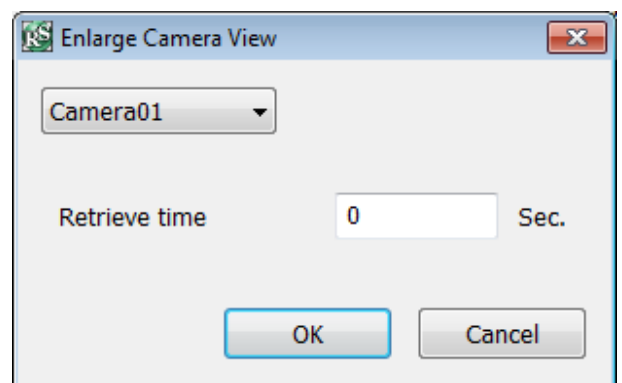

- Relay Output

Set to enable/disable the relay operation when the alarm is activated and to extend additional time in second before it stops the relay operation.

1. Beside the Relay Output check box, click **Detail**.
2. In the Alarm Relay dialog box, select from the available relay list and in the ON column, set to enable/disable the relay operation when the alarm is activated.
3. In the Retrieve time check box, you may enable/disable to extend the relay operation time and set the duration in second.
4. Click **OK** to exit and accept the setting and **Cancel** to exit without saving the setting.

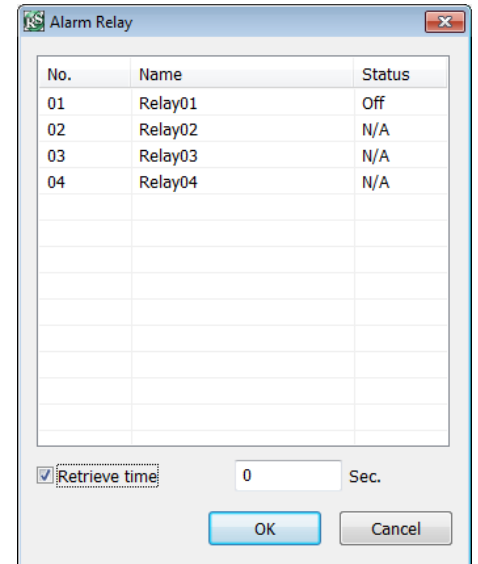

- Send E-mail

Send an electronic text message. Beside the Send Email check box, click **Detail**.

In the E-mail Setting dialog box, click **OK** to exit and save the setting and **Cancel** to exit without saving the setting.

➤ Mail Server

Enter the **SMTP Server** and **port**. If your e-mail system requires user identification, enable **Authentication** check box and enter **ID** and **Password**.

➤ Mail

Fill the mailing information.

- ✓ **From:** Enter the sender e-mail address.
- ✓ **To and CC:** Enter the recipient email address and separate it with comma or a semicolon (;).
- ✓ **Subject:** Enter the message title.
- ✓ **Message:** Type the message.

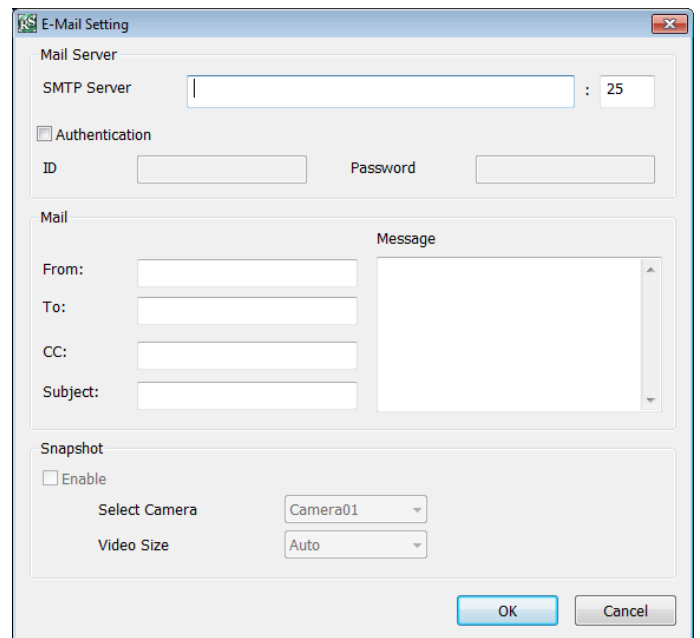

- Start Recording

Record the video from the selected camera.



EH5108/EH5108H/EXR5008 series only has 8 channels will be available.

Beside the Start Recording check box, click **Detail**.

1. In the Alarm Recording Setting dialog box, select the camera to enable/disable video recording. Enable **All** to select all cameras.
2. In the Frame Rate selection, select **As Setting** to record the number of frames based on the Recording Setting.
3. In the **Start Record prior** text box, mark and set the number in second for the program to begin recording after the alarm has been trigger. The time range is 1~10 seconds.
4. In the **Stop Record after** text box, mark and set the number in second for the program to continue recording after the alarm has ended. The time range is 1~999 seconds. If user doesn't mark and set the time, the alarm recording will continue recording until alarm is reset.
5. Click **OK** to accept the new settings and **Cancel** to exit without saving.

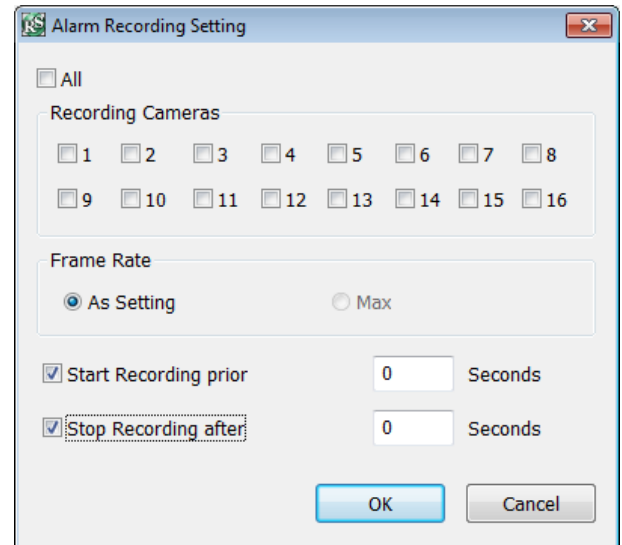

- PTZ preset point

Position the PTZ camera based on the preset point setting.

Beside the PTZ preset point check box, click **Detail**. In the Trigger PTZ Preset Setting dialog box, select the PTZ camera number then select the **Enable** check box. Select the position of the PTZ camera when the alarm is activated and ended. For the PTZ camera end point, user can also select on preset position or **Auto Pan** between preset position groups.

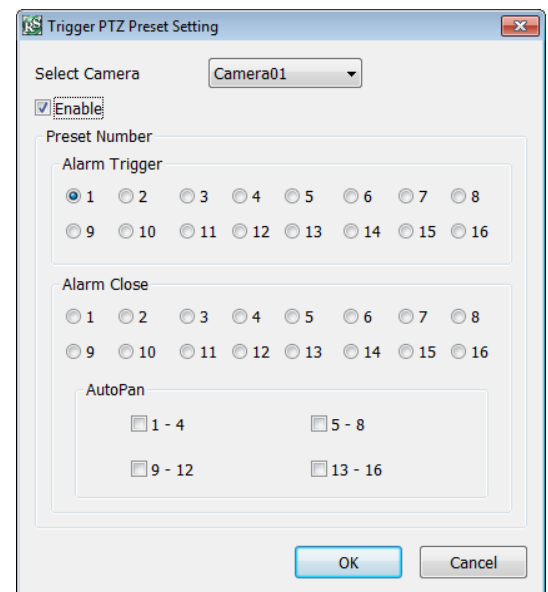

- Send to CMS (Central Management System)

Enable/disable the selected camera to send video to CMS when the alarm is activated. Beside the Send to CMS check box, click **Detail**. In the CMS Setting, select the camera to enable/disable sending the video to CMS. Enable **All** to select all cameras. Then, click **OK** to accept the new settings and **Cancel** to exit without saving.

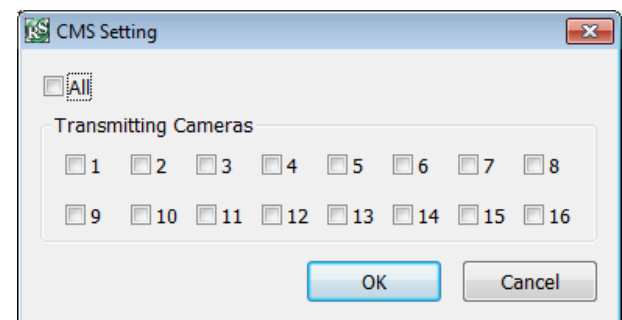

EH5108/EH5108H/EXR5008 series only has 8 channels will be available.

6.2 Familiarizing the Buttons in WebViewer PTZ



| Name | Function |
|-----------------------------------|---|
| (1) Direction buttons | Adjust and position the focal point of the PTZ camera. Click the center to pan automatically. |
| (2) Zoom +/- | Zoom in and out the image. |
| (3) Select PTZ | Choose to enable/disable the PTZ camera. In the Select PTZ dialog box, Select column, click to enable/disable viewing and controlling the PTZ camera. Click OK to exit and save the setting and Cancel to exit without saving the setting. |
| (4) Focus +/- | Adjust the focus manually to produce clear image. |
| (5) AutoPan Groups | Operate the PTZ cameras automatically based on the selected camera group preset position number. |
| (6) Camera preset position number | Move the PTZ camera to the preset point. The reset point (1~9) is based on the user has setup by remote control at local site. |

6.3 Familiarizing the Buttons in Remote Console

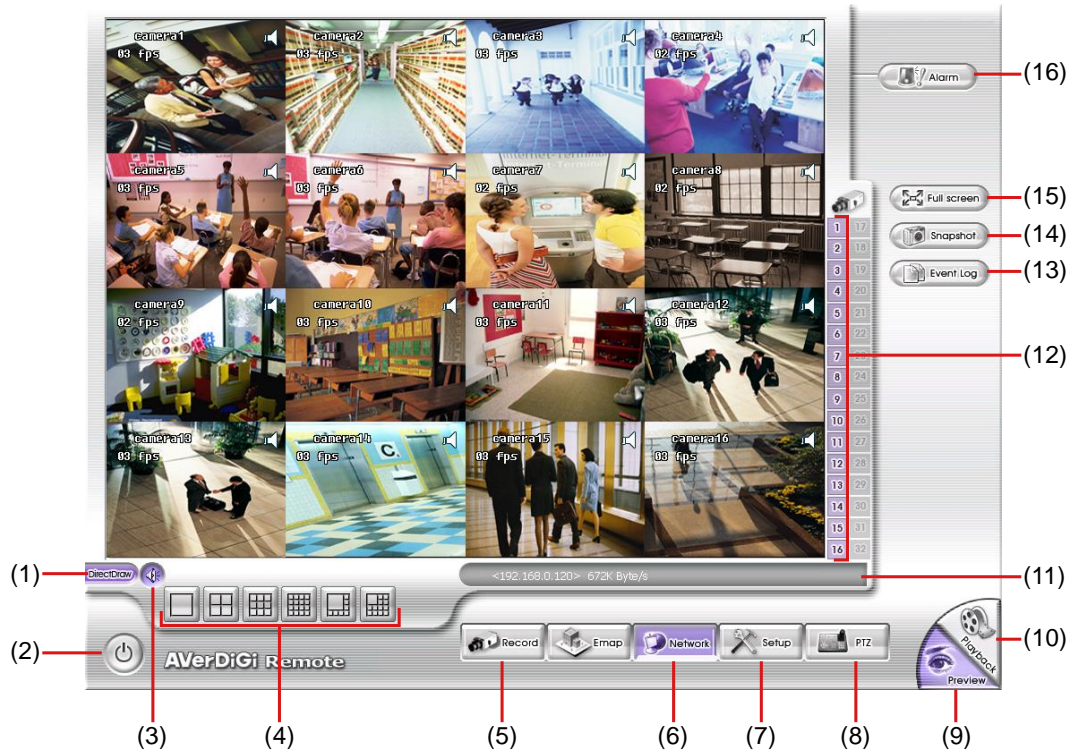

| Name | Function |
|--------------------------|--|
| (1) DirectDraw | Enhance the video quality. |
| i (1) Direct Draw | Direct Draw function supports for certain VGA card. For more information, please contact your VGA card vendor. |
| (2) Exit | Close the Remote Console. |
| (3) Audio button | Enable/disable the sound. |
| (4) Split Screen Mode | Select from 6 different split screen type to playback the recorded video file of all the camera, or one camera over the other or alongside on a single screen. If there are only 8 cameras, you won't be able to switch to 13 and 16 split screen mode. |
| (5) Record | Start/stop video recording. |
| (6) Network | Enable/disable remote system access. This feature allows you to access DVR server from a remote location via internet connection. |
| (7) Setup | Configure the Remote Console setting. (see also Chapter 6.3.1) |
| (8) PTZ | Access PTZ control panel. EH supports IP camera PTZ function.(see Chapter 6.3.2) |
| (9) Preview | Switch to Preview/Playback mode. This allows you to view live camera display. |
| (10) Playback | Switch to Playback mode. This allows you to view the recorded video file. (see also Chapter 6.4) |
| (11) Status Bar | Display the current date, time and hard disk free space. |
| (12) Camera ID | Show the number of cameras that are being viewed. When you are in single screen mode, click the camera ID number to switch and view other camera. |
| (13) Event Log | Display the Event logs, Operation logs, System logs, and Network logs. |
| (14) Snapshot | Capture and save the screen shot either in *.jpg or *.bmp format. |
| (15) Full screen | Use the entire area of the screen to only display the video. To return, Right-click the mouse or press ESC on the keyboard. |
| (16) Alarm | Alert and display warning info. Superuser and user both can reset the alarm. |

6.3.1 To Setup Remote Console Setting

Click **Setup** button to call out the **System Setting** windows. Click **OK** to exit and save the setting and **Cancel** to exit without saving the setting.

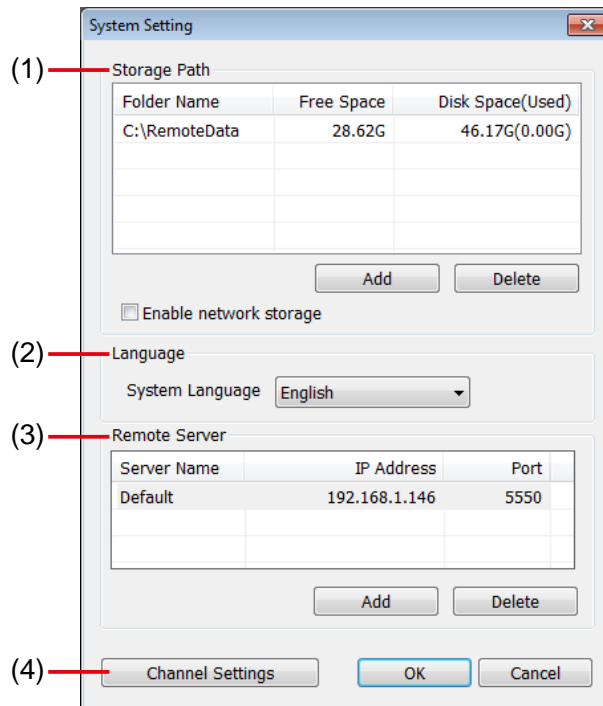

(1) Storage Path

Set the directory on where to save the data. When there is not enough free space to record one hour data, the system automatically replaces the oldest data. In case you have more than one storage path, the system automatically saves the data to the next storage path. By default the data is stored in C:\RemoteData, to insert another storage path, click **Add**. To remove the selected path, click **Delete**.

- **Enable network storage**

Select the Enable network storage check box to send the recorded video in network-attached storage.



To add network storage, the Internet storage drive/folder must be mapped as Network Driver in DVR server. To know how to assign or connect to a network drive, please refer to your Windows help file and search "Map Network drive".

(2) Language

Customize the system to display the tool tips and dialogs based on the selected language. By default the language is in English.

(3) Remote Server

Enter the DVR Server IP and Server Port number.

(4) Channel Settings



EH5108/EH5108H/EXR5008series only has 8 channels will be available.

The numbers from 1 to 16 represent the camera ID. In Transmitting Channels section, enable the camera number to receive the camera signal from the server. In Visible Channels section, enable the camera number to view the camera signal on Remote Console screen. To select all the cameras, enable the **ALL** check box.

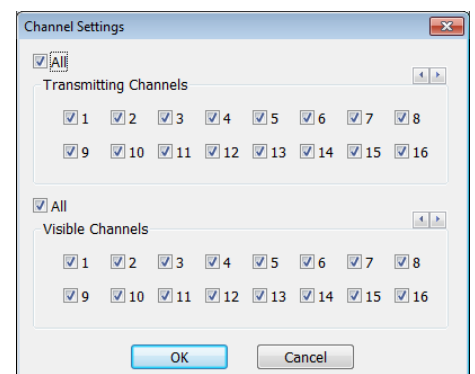

6.3.2 Familiarizing the Buttons in PTZ Camera Controller

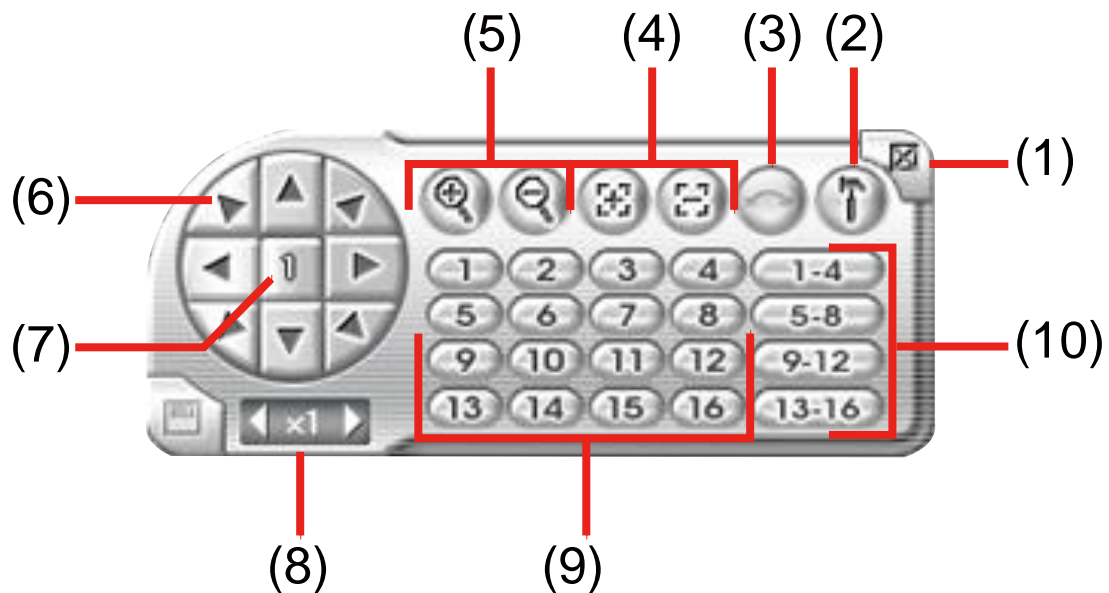

| Name | Function |
|-----------------------------------|--|
| (1) Close | Exit PTZ camera controller. |
| (2) Setup | Configure PTZ cameras. |
| (3) AutoPan | Operate the PTZ cameras automatically based on the selected camera group preset position number. |
| (4) Focus +/- | Adjust the focus manually to produce clear image. |
| (5) Zoom +/- | Zoom in and out the image. |
| (6) Direction buttons | Adjust and position the focal point of the PTZ camera. |
| (7) Camera ID pane | Display the PTZ camera number that is being operated. |
| (8) Camera lens speed controller | Adjust the moving speed of the PTZ camera lens. |
| (9) Camera preset position number | Move the PTZ camera to the preset point. |
| (10) Group AutoPan | Select to automatically operate PTZ camera in group. |

6.4 Using the Remote Playback

To use this feature, first you need to select the source of the file. In the Select Playback Mode dialog box, choose **Local Playback** to open the file that is recorded in the Remote Console, and **Remote Playback** to open the file that is recorded in the DVR server. When you choose Remote Playback, select **RealTime Playback** if your internet bandwidth is fast and big enough, otherwise choose **Download and Playback**.



Click **OK** to proceed and **Cancel** to void this operation.





In the Video Playback Date/Time Selection, the number from 00 to 23 represent the time in 24-hour clock. The numbers from 01 to 8 represent the camera number.

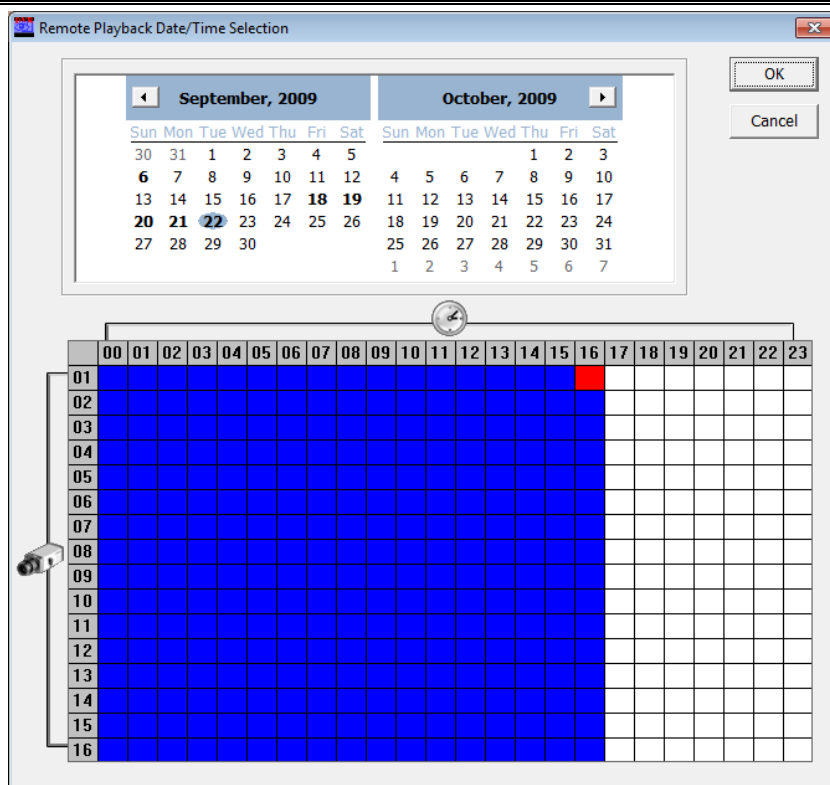

EH5108/EH5108H/EXR5008 series only has 8 channels will be available.



To Make a Selection:

1. Select the date in the calendar. Use  and  buttons to shift the calendar to the left or right.
2. In the table below, click on the blue block to select and open the recorded file. The blue block turns red when it is selected. The block that appears in white doesn't have data. You can only select one block when you choose Download and Playback.
3. Click **OK** to proceed and **Cancel** to void this operation.
4. If you select Download Playback and after making the selection, the system divides the selected hour into 16

video thumbnails. In the Time Selection screen, click on the video thumbnail you want to download (see also [Chapter 6.4.3](#)).

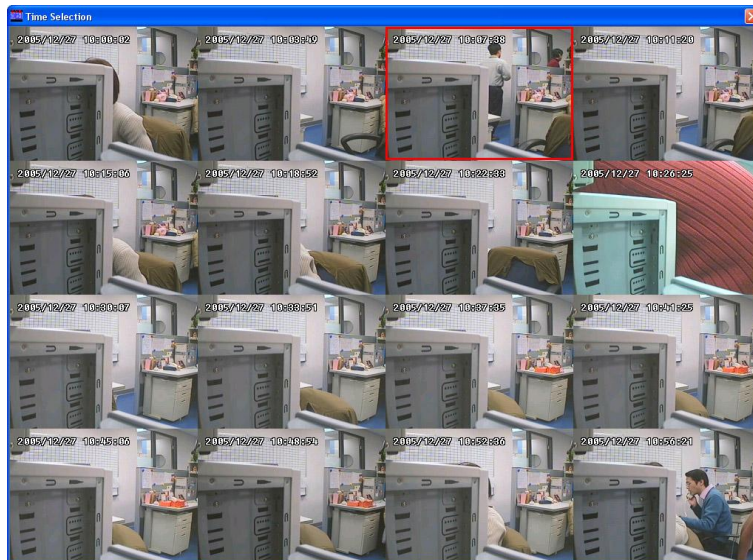

6.4.1 Familiarizing the Buttons in Local Playback

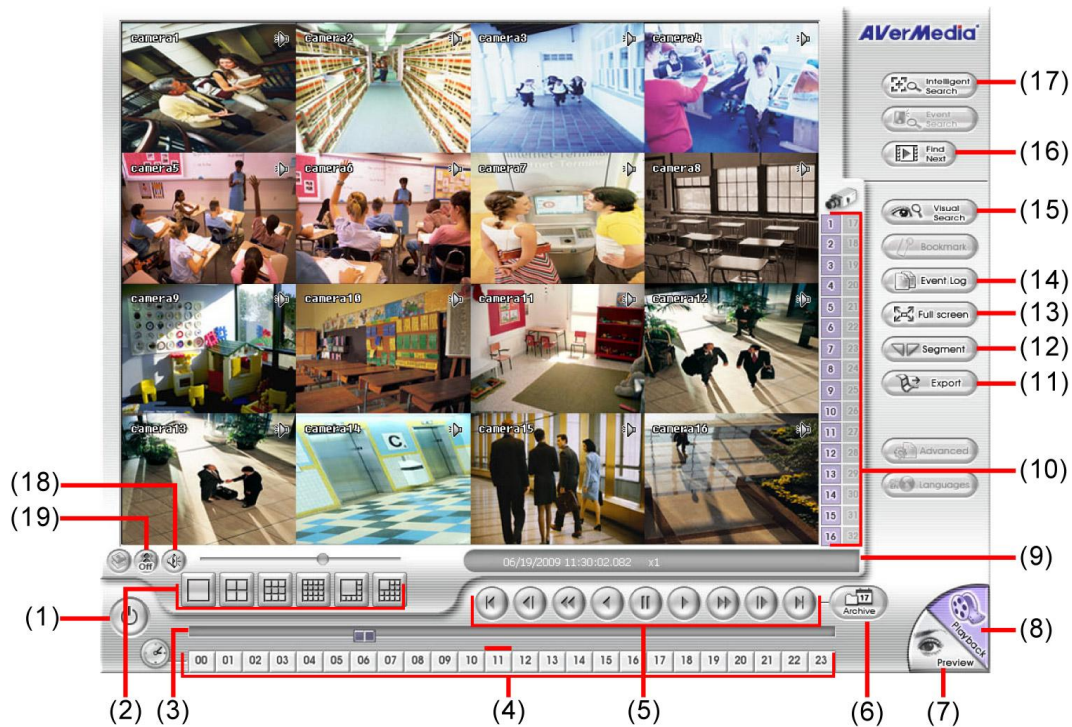

| Name | Function |
|-----------------------|--|
| (1) Exit | To close the application |
| (2) Split Screen Mode | Select from 6 different split screen type to playback the recorded video file of all the camera, or one camera over the other or alongside on a single screen. |
| i | <ul style="list-style-type: none"> - If there are only 8 cameras, you won't be able to switch to 13 and 16 split screen mode. - To zoom in an area on the screen, Right click and Drag a square on the area you want to enlarge. To back to normal view, right click the channel screen again. |
| (3) Progress bar | Show the progress of the file being played. You may move the bar to seek at any location of the track. |
| (4) Hour Buttons | Select and click to playback the recorded video file on the specific time frame. |
| i | The Hour buttons represent the time in 24-hour clock. The blue bar on top of the hour button indicates that there is a recorded video file on that period of time. If there is no recorded data within the hour, there will be no color bar on top of the hour button. While the red bar indicates that you are currently viewing the recorded video file. |

| Name | Function |
|--|---|
| (5) Playback Control Buttons | <p>Begin: Move at the beginning of the recorded video file.</p> <p>Previous: Go back to the previous frame.</p> <p>Slower: Play the recorded video file at the speed of 1/2x, 1/4x, 1/8x, 1/16x, or 1/32x.</p> <p>Rewind: Wind back the video file.</p> <p>Pause: Briefly stop playing the recorded video file.</p> <p>Play: Play the recorded video file.</p> <p>Faster: Play the recorded video file at the speed of 2x, 4x, 8x, 16x or 32x.</p> <p>Next: Go to the next frame.</p> <p>End: Go to the end of the video file.</p> |
| (6) Date | Select the date on the calendar and the time from 00 to 23 to where to start playing the recorded video file. |
|  | The numbers from 00 to 23 represent the time in 24-hour clock. The numbers from 01 to 16 represent the camera ID. While the red colored column indicates on where to start playing the recorded video file. If there is no any video data, it will be no color bar on top of the date button. |
| (7) Preview | Switch to Preview mode. |
| (8) Playback | Switch to Playback mode. This allows you to view the recorded video file. |
| (9) Status bar | Display the record date, time, HDD capacity in preview mode and play speed in playback mode. |
| (10) Camera ID | Show the number of cameras that are being viewed. When you are in single screen mode, click the camera ID number to switch and view other camera. |
| (11) Export | Export includes Snapshot, Print, and Output Video Clip function. <ul style="list-style-type: none"> ■ Snapshot: Capture and save the screen shot either in *.jpg format. ■ Print: Print the screen shot. ■ Output Video Clip: Save the segmented file in *.dvr format (see also Chapter 6.4.1.1). |
| (12) Segment | Keep a portion of the recorded video you want (see also Chapter 6.4.1.1). |
| (13) Full screen | View in Playback-compact mode. To return, press the right button of the mouse or ESC on the keyboard. |
| (14) Event Log | Show the record of activities that take place in the system |
| (15) Visual Search | Search from a specific camera by Date, Hour, Minute, 10 Seconds and Second(also see Chapter 4.3.5). |
| (16) Find Next | Search for the next event. You can use this when you are using Event Search function. |
| (17) Intelligent Search | Search the changes in the motion detector frame (See also Chapter 4.3.7). |
| (18) Audio | Enable/disable volume |
| (19) De-interlace | To enhance the video quality. Set the de-interlace mode to #1, if you are capturing motionless picture and #2, if it captures lots of movement. |

6.4.1.1 To Cut and Save the Wanted Portion of the Recorded Video

1. Use the Playback Control buttons or drag the bar on the playback progress bar and pause on where you want to start the cut. Then, click Segment to set the begin mark.



2. Use the Playback Control buttons or drag the bar on the playback progress bar and pause on where you want to end the cut. Then, click Segment to set the end mark. To cancel segmentation or set the segment marks from the start, click Segment button again.



3. Click **Export > Output Video Clip** button to save the wanted clip.
4. In the Save As dialog box, locate on where you want to save the file or choose to **Burn** the video segment to VCD/DVD ROM (only for *.mpeg file format).
5. Select the file type and select the camera information display position when playback. The camera information will be the information of server name that user has defined in Network Setting.
6. If the select the file type is *.avi, user can mark **included audio** to include audio in output video segment.

7. To adjust **Video Quality** if needed.
8. And, select the **Optimize for speed** for faster file opened. For saving storage, select **Optimize for storage**.
9. Click **Save** to save the video segment.

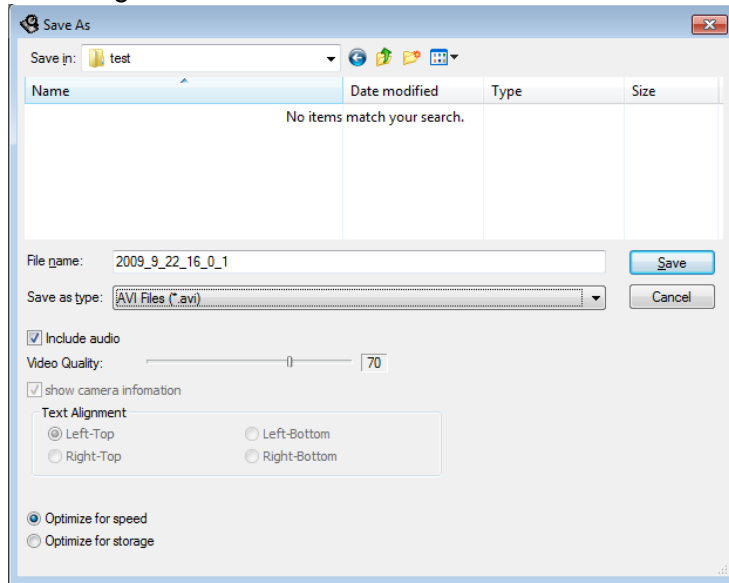

6.4.2 Familiarizing the Buttons in RealTime Playback



| Name | Function |
|-----------------------|--|
| (1) Exit | To close the application |
| (2) Split Screen Mode | Select from 6 different split screen type to playback the recorded video file of the entire camera, or one camera. |

- i** - If there are only 8 cameras, you won't be able to switch to 13 and 16 split screen mode.
- To zoom in an area on the screen, **Right** click and **Drag** a square on the area you want to enlarge.

| | |
|------------------|--|
| (3) Progress bar | Show the progress of the file being played. You may move the bar to seek at any location of the track. |
| (4) Hour Buttons | Select and click to playback the recorded video file on the specific time frame. |

- i** The Hour buttons represent the time in 24-hour clock. The blue bar on top of the hour button indicates that there is a recorded video file on that period of time. While the red bar indicates that you are currently viewing the recorded video file.

| Name | Function |
|--|--|
| (5) Playback Control Buttons | <p>Begin: Move at the beginning of the recorded video file.</p> <p>Previous: Go back to the previous frame.</p> <p>Slower: Play the recorded video file at the speed of 1/2x, 1/4x, 1/8x, 1/16x, or 1/32x.</p> <p>Rewind: Wind back the recorded video file.</p> <p>Pause: Briefly stop playing the recorded video file.</p> <p>Play: Play the recorded video file.</p> <p>Faster: Play the recorded video file at the speed of 2x, 4x, or 8x, 16x or 32x.</p> <p>Next: Go to the next frame.</p> <p>End: Go to the end of the recorded video file.</p> |
| (6) Date | Select the date on the calendar and the time from 00 to 23 to where to start playing the recorded video file. |
|  | The numbers from 00 to 23 represent the time in 24-hour clock. The numbers from 01 to 16 represent the camera ID. The blue colored column indicates that there is a recorded video file on that period of time. While the red colored column indicates on where to start playing the recorded video file. |
| (7) Preview | Switch to Preview/Advanced mode. |
| (8) Playback | Switch to Playback mode. This allows you to view the recorded video file. |
| (9) Status bar | Display the recorded date, time and play speed. |
| (10) Camera ID | Show the number of cameras that are being viewed. When you are in single screen mode, click the camera ID number to switch and view other camera. |
| (11) Export | Snapshot: Capture and save the screen shot either in *.jpg or *.bmp format. |
| (12) Full screen | View in Playback-compact mode. To return, press the right button of the mouse or ESC on the keyboard. When you switch to full screen in multiple-screen mode, Left click to toggle to only display one of the video in the multiple-screen mode or all. |
| (13) Event Log | Show the record of activities that take place in the system |
| (14) Audio | Enable/disable volume |
| (15) De-interlace | To enhance the video quality. Set the de-interlace mode to #1, if you are capturing motionless picture and select #2, if it captures lots of movement. |

6.4.3 Familiarizing the Buttons in Download and Playback



| Name | Function |
|------------------------------|--|
| (1) Exit | To close the application. |
| (2) Progress bar | Show the progress of the file being played. You may move the bar to seek at any location of the track. |
| (3) Playback Control Buttons | <p>Begin: Move at the beginning of the recorded video file.</p> <p>Previous: Go back to the previous frame.</p> <p>Slower: Play the recorded video file at the speed of 1/2x, 1/4x, or 1/8x.</p> <p>Rewind: Wind back the recorded video file.</p> <p>Pause: Briefly stop playing the recorded video file.</p> <p>Play: Play the recorded video file.</p> <p>Faster: Play the recorded video file at the speed of 2x, 4x, or 8x, 16x or 32x.</p> <p>Next: Go to the next frame.</p> <p>End: Go to the end of the recorded video file.</p> |
| (4) Status bar | Display the recorded date, time and play speed. |
| (5) Language | Customize the system to display the tool tips and dialogs based on the selected language. By default the language is in English. |
| (6) Export | <p>Export includes Snapshot, Print, and Output Video Clip function.</p> <ul style="list-style-type: none"> ■ Snapshot: Capture and save the screen shot either in *.jpg or *.bmp format. ■ Print: Print the screen shot. ■ Output Video Clip: Save the segmented file in *.mpg, *.avi, or *.dvr format (see also Chapter 6.4.1.1). |
| (7) Segment | Keep a portion of the recorded video you want (see also Chapter 6.4.1.1). |
| (8) Full screen | <p>View in Playback-compact mode. To return, press the right button of the mouse or ESC on the keyboard.</p> <p>When you switch to full screen in multiple-screen mode, Left click to toggle to only display one of the video in the multiple-screen mode or all.</p> |
| (9) Event Log | Show the record of activities that take place in the system |
| (10) Visual Search | Search from a specific camera by Date, Hour, Minute, 10 Seconds and Second. (See also Chapter 4.3.5). |
| (11) Audio | Enable/disable volume |
| (12) De-interlace | To enhance the video quality. Set the de-interlace mode to #1, if you are capturing motionless picture and select #2, if it captures lots of movement. |

Users can use a mobile phone to access the DVR through Internet. Make sure your mobile phone support IE browser and is connected to the internet. To access the DVR server, open IE browser and enter **http://enter server IP or domain name here/mobile**. You can see the latest screen shot. Click << >> to change the channel or camera and **Refresh** to reload new screen shot.

7.1 Using PDAViewer to Access DVR Server

Users can also use a PDA to access the DVR through Internet. Make sure your PDA support IE browser and is connected to the internet. To use this feature, you need to install the PDA Viewer software either thru ActiveSync connection or download it from the internet. Please check if your PDA meets the 2 requirements below.

OS: MS Windows CE 4.0, PocketPC 2002/2003, Mobile 5 PDA version
CPU: ARM architecture

7.1.1 To Install PDAViewer thru ActiveSync

1. Connect your PDA to your PC. Place the CD into the CD-ROM drive then click **Utilise** and select the **PDAViewer** fold and click **setup.exe** to install the PDAViewer program. And follow the on screen instructions.
2. Click **Next** to continue.
3. Read the license agreement and click **Yes** to accept all the terms. The system will then automatically install the application.

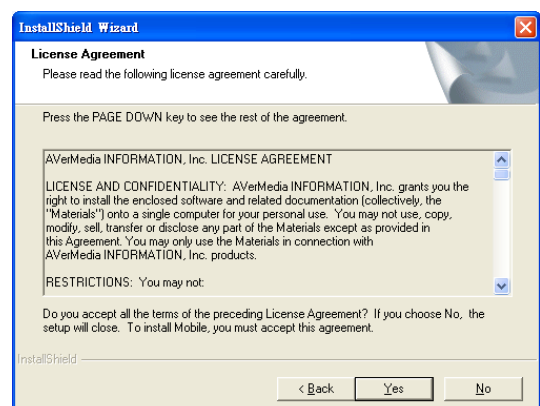
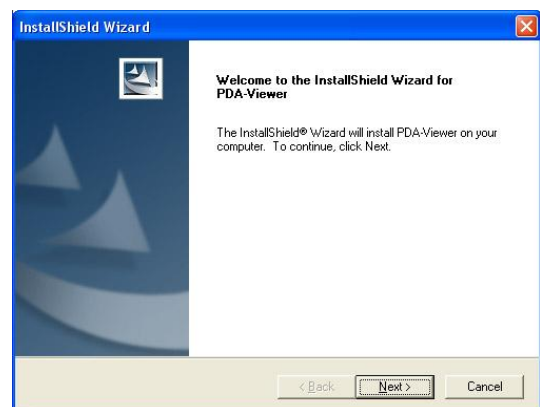

7.1.2 To Install PDAViewer from the Internet

Make sure you are connected to the internet.

1. Open the web browser and enter the server IP. Then click the hyperlink **Download PDAViewer**.



2. When the Download dialog box appears, enable **Open file after download** and click **Yes**.



3. After the installation, the PDAViewer icon will appear in the Programs list.



7.1.3 To Use the PDAViewer

1. Run the **PDAViewer** on your PDA.
2. Familiarizing the PDAViewer buttons.

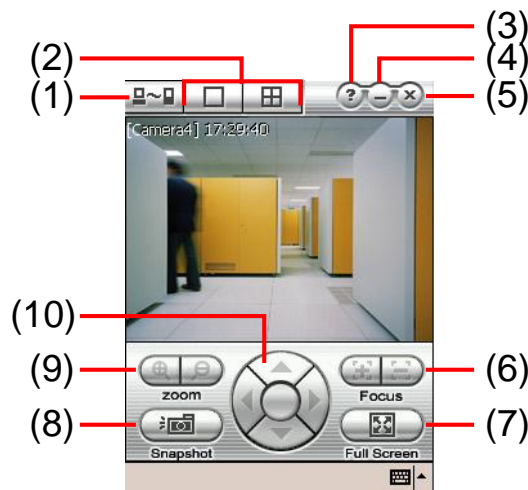

| Name | Function |
|------|----------|
|------|----------|

- | | |
|-------------|---|
| (1) Connect | Hook up to the DVR server. Make sure you are connected to internet. When the iView screen appears, click Add to add DVR server. |
|-------------|---|

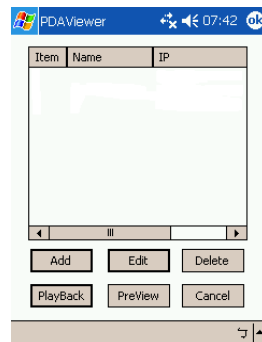

Enter the server IP, port, user ID, password and select the connection type. Then, click **OK**.

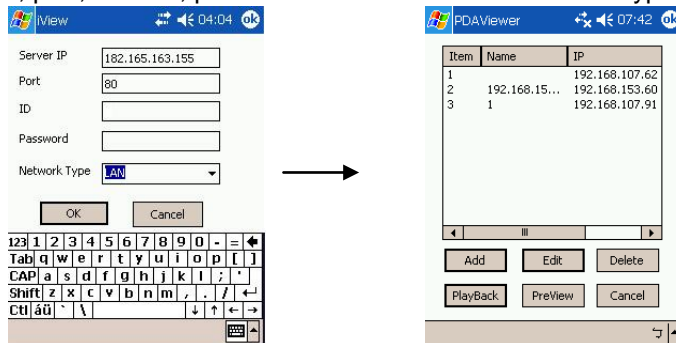

User can playback the recorded video from remote DVR server in PDAViewer.(see also [Chapter 7.1.4](#))

| | |
|------------------------|---|
| (2) Split Screen Mode | Select between 2 screen display types. It also allows you to switch and view different camera number or channels. |
| (3) About | Display the PDAViewer software version. |
| (4) Minimize | Reduce the size to taskbar. |
| (5) Exit | Close the PDAViewer. |
| (6) Focus | Adjust the focus of PTZ camera to produce clear image. |
| (7) Full Screen | Use the entire screen to only display the video. |
| (8) Snapshot | Capture and save the screen shot in *.bmp format. |
| (9) Zoom | Zoom in and out the PTZ camera image. |
| (10) Direction buttons | Adjust and position the focal point of the PTZ camera. |

- To change the video quality, enable/disable audio, and select to display different camera, tap on the video screen longer the pop-up menu will appear.



7.1.4 To Playback in PDAViewer

- Run the **PDAViewer** in the Programs.
- Hook up to the DVR server.
- Click **Connect** icon and select the DVR server
- Click **Playback** to enter playback option screen
- Select the **camera, data, and time**
- Click **Playback** to start playing the recorded video

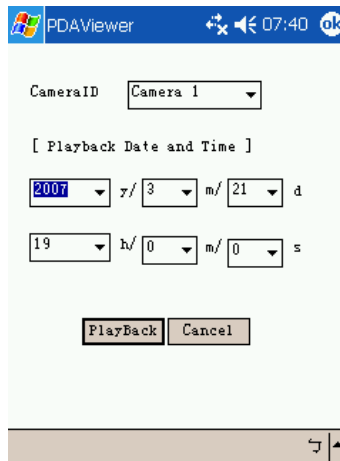

- While playback, user can view and change status of I/O devices
- On the playback screen, tap on video screen longer the pop up menu will appear
- Select the **Remote IO**



- The sensor and relay devices will list as below:

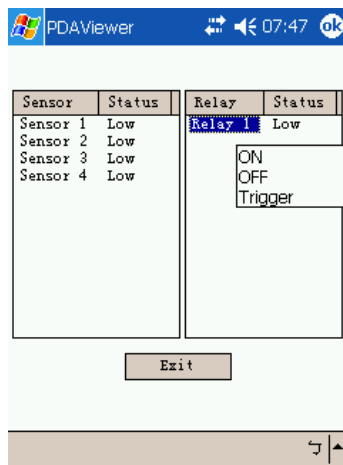

11. User can change the relay status. Select the relay and tap on video screen longer the popup menu will appear, and then, select the status (ON, OFF, Tigger)

7.2 Using JavaViewer to Access DVR Server

Using the mobile phone within Symbian Smart Phone OS to access the DVR through Internet. Make sure your mobile phone supports Symbian Smart Phone OS and can be connected to the internet. To use this feature, you need to install the JAVA Viewer program that it can be downloading it from the DVR server through the internet.

7.2.1 To install JavaViewer from the DVR Server

1. Open the web browser and enter the DVR server IP (http://DVR server IP: port/JAVA-Viewer.html). Then click **Connect**.
2. When the Download screen appears, select **JAVA-Viewer.jad** and download it to your mobile phone.
3. After the installation, the JavaViewer will be in your mobile phone system. To find the JavaViewer program where is located, please refer to your mobile phone user's manual.

7.2.2 To Use the JavaViewer

1. Run the JavaViewer program.
2. Enter the DVR IP address, port number, user ID, and password. Please refer to your DVR server setting for that information.
3. And then, select the Connect to connect to DVR server.
4. Click **Yes** to accept the data from DVR server.
5. When connection is success, you will see the camera video on the screen.
6. To switch to different camera view, select menu and select the channel.



7. The JAVAViewer support PTZ control function, you can refer to **Help** file for detail function control key. Select **menu** and go the way down to select the **Help** file.



The bundled Web Tools includes Dispatch Server, Remote Backup, and Remote Setup program. To install Web Tools, place the CD into the CD-ROM drive then click **Install Web Tool**.

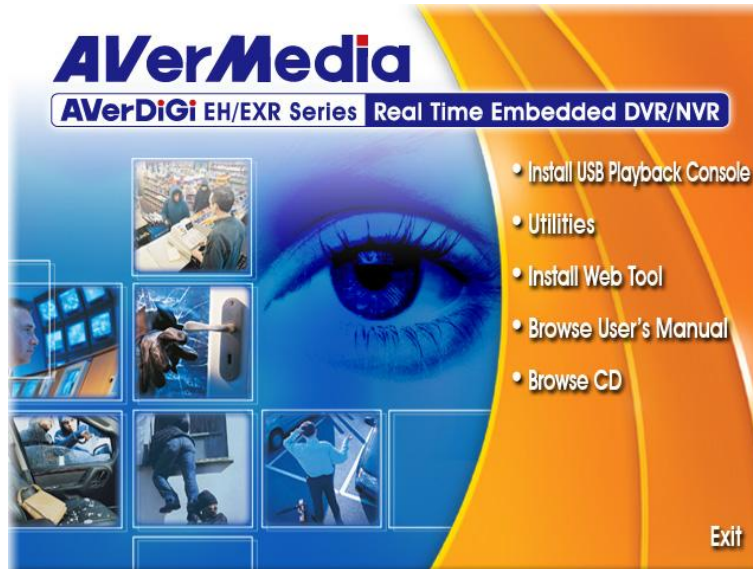

8.1 Dispatch Server

Dispatch is designed to reduce the network traffic of the DVR server. Instead of connecting directly to the DVR server, the client can connect to the computer that is connected to the DVR server using the Dispatch program.

i To have better remote live and playback performance, it's suggested to connect DVR to Dispatch Server in LAN environment, and then connect remote client to Dispatch Server via either WAN or LAN.

8.1.1 To Run Dispatch program:

1. Make sure you are connected to the internet.
2. Click **Start>Programs>DSS>Tool>Dispatch**.
3. In the DVR Server section, enter the NV DVR server IP, port, user ID and password. You can also select to display the language you prefer.
4. **Auto connect when start**
Enable to automatically connect the dispatch server when start up
5. **3GPP Service**
Enable to allow user using 3GPP service to receive video stream from Dispatch server. The **Service Port** must same as RTSP port of 3GPP on DVR server.
6. In the **Dispatch Service** section, if you have installed more than one network card, select the Service IP number.
7. In the **Dynamic DNS Configuration** section, enter the DNS server Name and Password. The DNS server can be the remote storage server for sharing the DVR system loading.
8. Click **START** to connect.

8.2 Remote Setup

Remote Setup is a tool for configuring DVR server from remote site. To install Remote Setup application, insert the Installation CD into CD-ROM drive and click **Web Tools**. After installation, click  to start the Remote Setup application.

8.2.1 To Add DVR server

User need to add a DVR server and make connection in order to setup remote DVR server.

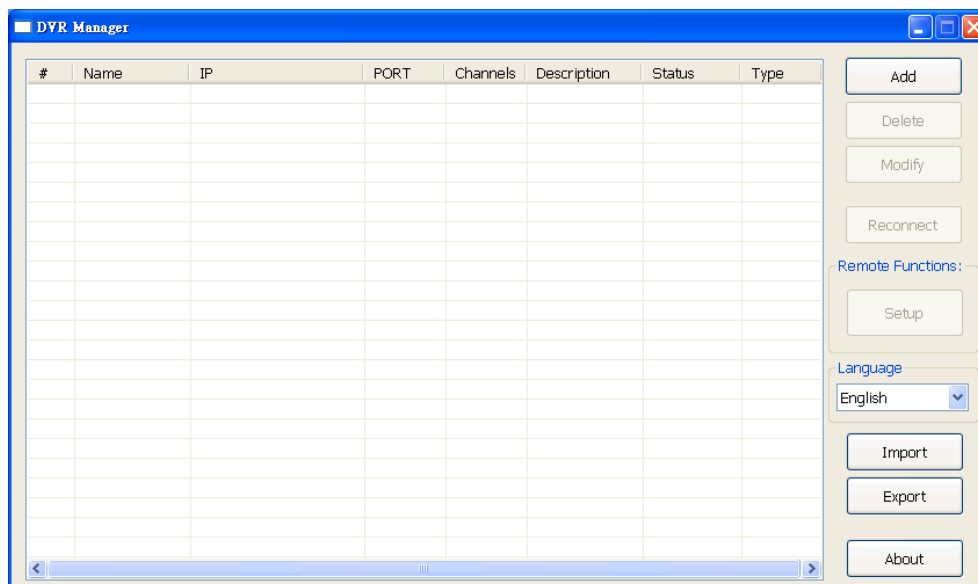

1. Click **Add**
2. In Edit DVR windows, fill in the following items:
 - **Name:** give a name for remote DVR server for easy managing
 - **IP:** fill in remote DVR server's IP address
 - **Port:** the port use to connect to remote DVR server. The port number is same the Webviewer port on the remote DVR server. The default is 80.
 - **User ID:** fill in the remote DVR server's login account
 - **Password:** fill in the remote DVR server's login password
 - **Description:** fill in a short description for the remote DVR server

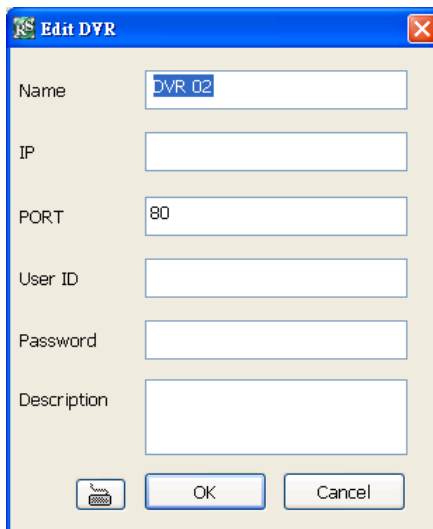

3. Click **OK** to complete adding remote DVR server.
4. The added DVR server will be listed and auto connects to DVR server.
5. Once the connecting is success, user can start to configure DVR server.
6. When connection is lost, click **Reconnect** to connect again.
7. To modify or delete the added DVR server, select the DVR server from listing and click **Modify** to change the

setting and click **Delete** to remove the DVR server.

8. User also can import the setting by clicking **Import** button. To save the setting to local hard disk, click **Export** button.

8.2.2 To Setup Remote System Setting

The setting here applies to Remote DVR only.

8.2.2.1 System Setting

In the System Setting windows, click **Update** to accept the new settings, click **Exit** to exit without saving, and click **Default** to revert back to original factory setting.

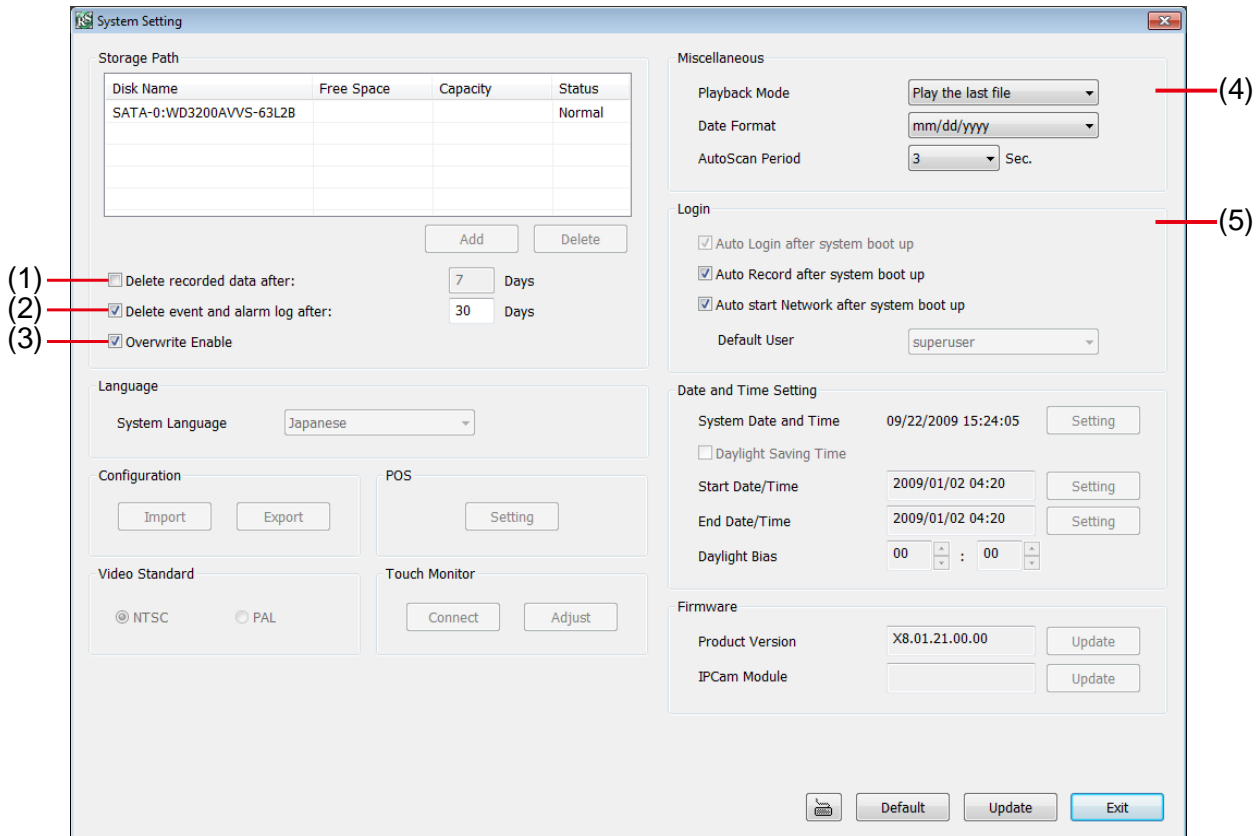

(1) Delete recorded data after

If you want the system to automatically erase the data after a certain days, enable the **Delete recorded data after** check box and enter the numbers of days in **Days** text box.

(2) Delete event and alarm log after

If you want the system to automatically erase the event and alarm log files after a certain days, enable the **Delete event and alarm log after** check box and enter the numbers of days in **Days** text box.

(3) Overwrite Enable

When there is not enough free space to record one hour data, the system automatically replaces the oldest data.

(4) Miscellaneous

Enable the conditions in **Miscellaneous** section you want the system to perform.

- Playback Mode

Select the mode of playback the video.

Select date and time: Select the date and time which user wants to playback.

Play the last file: Automatically playback the video from the last hour

Instant Playback: Automatically playback the video which has just recorded

- Date Format

Select the date format which wants to display in **Select date and time** playback mode

- Auto Scan Period

Set the time gap of the Auto Scan function from 3 to 10 seconds. This automatically switches to the next video in cycle depending on the set time gap.

(5) Login

Enable the conditions in Login section you want the system to automatically carry out.

- **Auto record when login**
Automatically start video recording when the DVR is executed.
- **Auto start Network when login**
Automatically connect to network when the DVR is executed.

8.2.2.2 Camera Setting

Select the camera from remote DVR servers to modify settings. In the Camera Setting windows, click **Update** to save and apply the new settings, click **Exit** to exit without saving.

IP Camera Setting



EH5108/EH5108H/EXR5008 series only has 8 channels will be available.

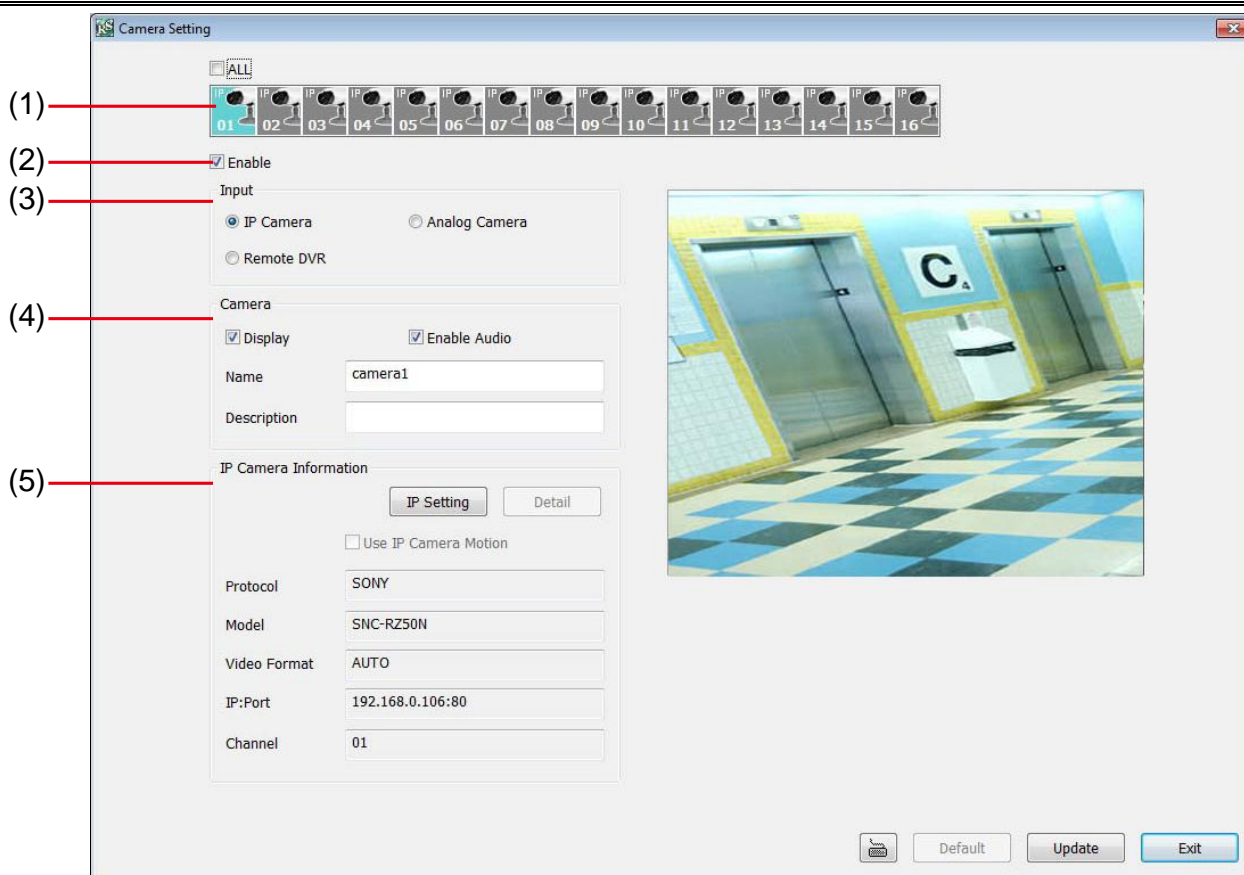

(1) Camera Icons

Select the camera number you want to adjust the video setting. To select all the cameras, enable the **ALL** check box. To select more than one camera, Right click on the camera icon. To select one camera only, Left click on the camera icon. The camera icon turns red when it is selected.

(2) Enable

Set to enable/disable the selected camera. When there is no video source on the camera, we suggest disabling it so that the system won't detect it as video loss error.

(3) Input

Select the type of camera as IP camera. For General camera setting, see [Analog Camera Setting](#). To modify camera of remote DVR, see [Remote DVR Camera Setting](#).

(4) Camera

- Display

Enable/disable to show the video. Even if the video of the selected camera is hidden you can still record the video and preview it in playback mode.

- Enable Audio

Enable/disable audio of the camera.

- Name

Change the camera name

- Description

Add a short comment

(5) IP Camera Information

To setup IP camera and display current IP camera information.

- **IP Setting:** Click **IP setting** to add the IP camera.

The screenshot shows a window titled "IP Camera Settings" with a close button in the top right corner. The window is divided into two main sections. The top section, "IP Camera Information", contains several dropdown menus: "Protocol" (selected with a radio button, set to "SONY"), "Model" (set to "SNC-RZ50N"), "Video Format" (set to "AUTO"), and "Channel" (set to "1"). To the right of the "Protocol" dropdown is a "Search Devices" button. Below these is the "IP Camera Site" section, which has two input fields: one for the IP address (containing "192.168.0.106") and one for the port (containing "80"). The bottom section contains two radio buttons: "Protocol" (selected) and "URL" (unselected). Below the "URL" radio button is a text input field containing "http://". There is also a checked checkbox for "Authentication". Below this are two more input fields: "ID" (containing "admin") and "Password" (containing six dots). At the bottom right of the window are "OK" and "Cancel" buttons.

1. Click the radio button of **Protocol** to start setup IP camera.
2. Select the **Protocol**, **Model**, **Video Format**, and **Channel** of the IP camera.
3. Enter IP address and connecting port in **IP Camera Site** column.
4. Also, user can enter URL of IP camera instead of IP address.
5. If the IP camera has authority request, please enable **Authentication** and enter **ID** and **Password**.
6. Click **OK** to connect with the IP camera.

Analog Camera Setting

Select the camera from remote DVR servers to modify settings. In the Camera Setting windows, click **Update** to save and apply the new settings, click **Exit** to exit without saving.

i EH5108/EH5108H/EXR5008 series only has 8 channels will be available.

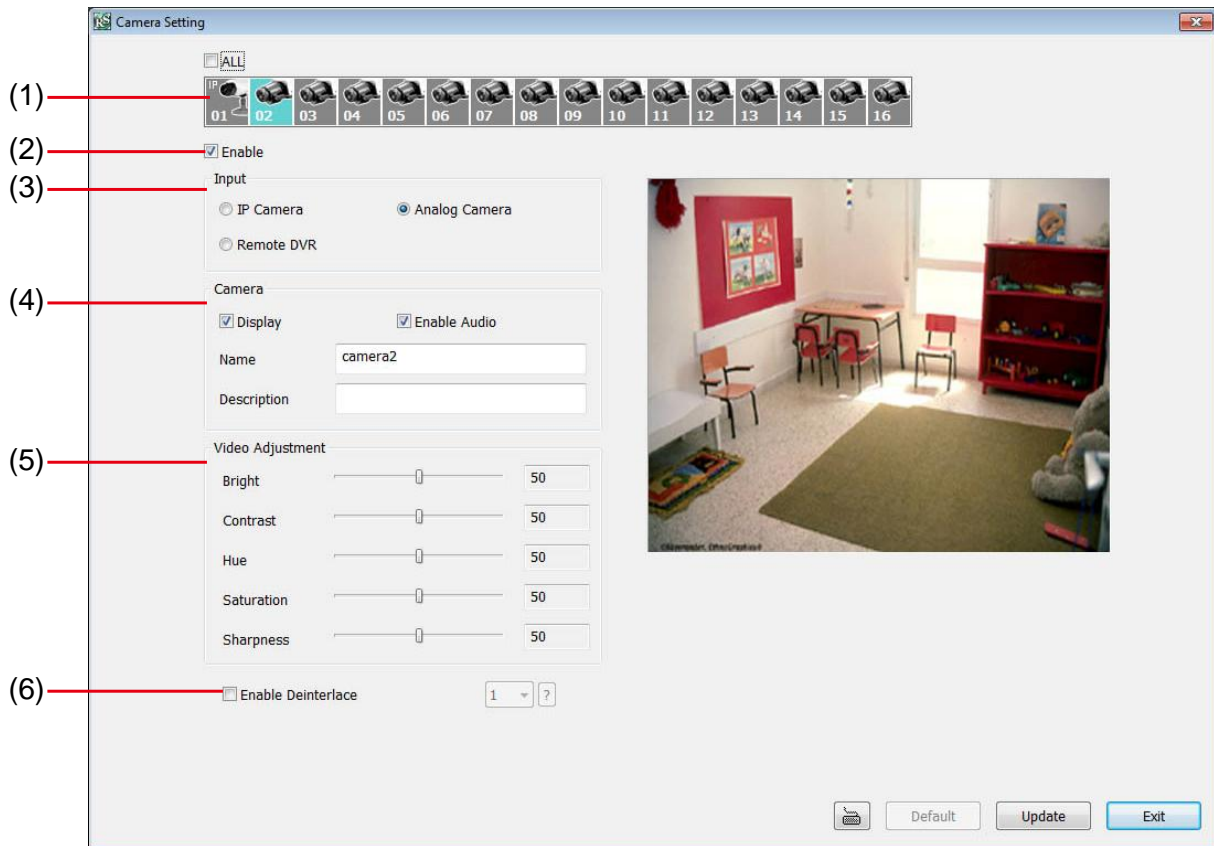

(1) Camera Icons

Select the camera number you want to view. To enable/disable all cameras, click **ALL** check box.

(2) Enable

Set to enable/disable the selected camera. When there is no video source on the camera, we suggest disabling it so that the system won't detect it as video loss error.

(3) Input

Select the camera type as **General Camera**. For IP camera setting, see [IP Camera Setting](#). To modify camera of remote DVR, see [Remote DVR Camera Setting](#).

(4) Camera

- Display

Enable/disable to show the video. Even if the video of the selected camera is hidden you can still record the video and preview it in playback mode.

- Enable Audio

Enable/disable audio of the camera.

- Name

Change the camera name

- Description

Add a short comment

(5) Video Adjustment

Adjust the Brightness, Contrast, Hue and Saturation of the camera.

(6) Enable Deinterlace

Enhance the video quality. Set the **Enable Deinterlace** mode to #1, if you are capturing motionless picture and select #2, if it captures lots of movement.

Remote DVR Camera Setting

Select the camera to modify settings. In the Camera Setting windows, click **Update** to save and apply the new settings, click **Exit** to exit without saving.

i EH5108/EH5108H/EXR5008 series only has 8 channels will be available.

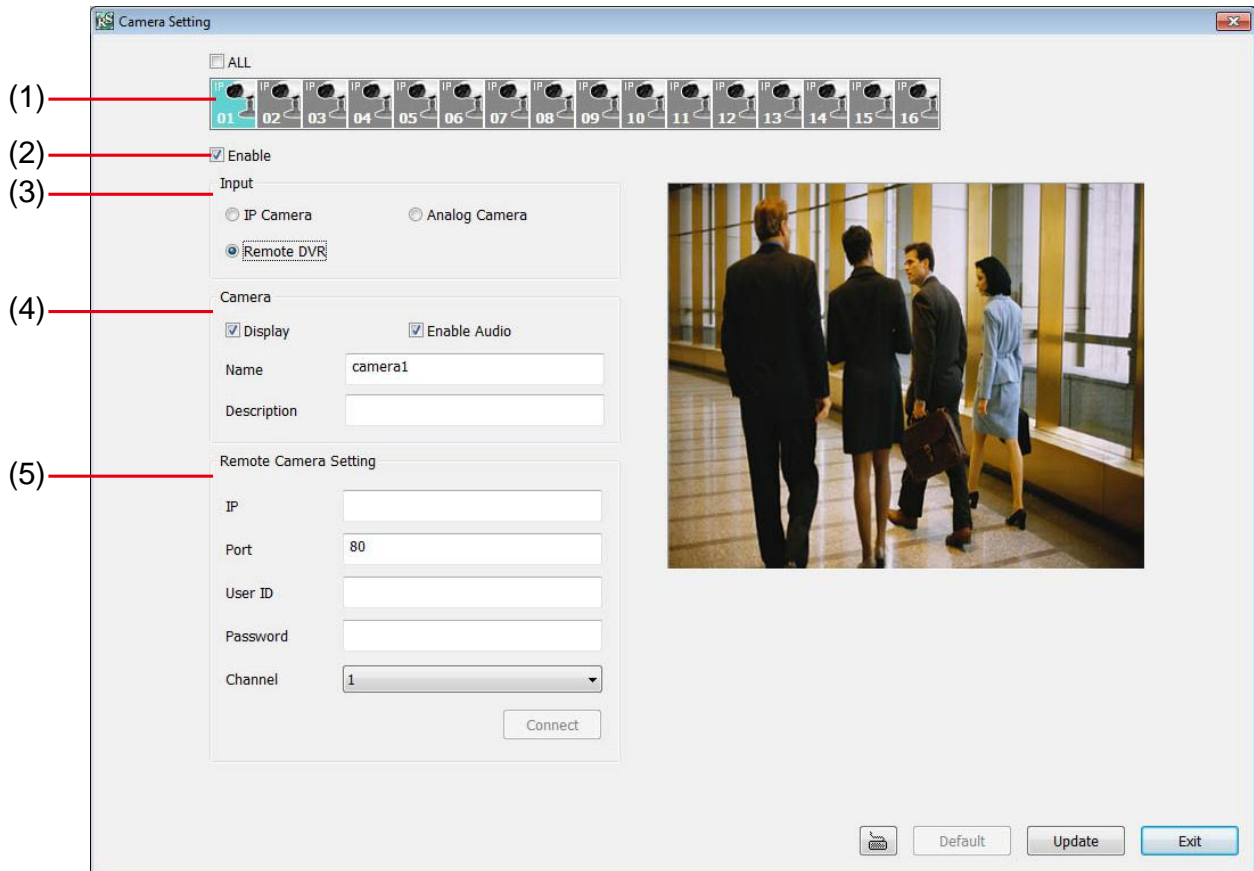

(1) Camera Icons

Select the camera number you want to view. To enable/disable all cameras, click **ALL** check box.

(2) Enable

Set to enable/disable the selected camera. When there is no video source on the camera, we suggest disabling it so that the system won't detect it as video loss error.

(3) Input

Select the camera type as **Remote DVR**. For IP camera setting, see [IP Camera Setting](#). To modify analog camera setting, see [Analog Camera Setting](#).

(4) Camera

- Display

Enable/disable to show the video. Even if the video of the selected camera is hidden you can still record the video and preview it in playback mode.

- Enable Audio

Enable/disable audio of the camera.

- Name

Change the camera name

- Description

Add a short comment

- IP

Enter the IP address of the camera

- Port

The port for connection

- **User ID**
Enter the user id that for connecting authority
- **Password**
Enter the password that is for connecting authority
- **Channel**
Select the channel of connected camera

8.2.2.3 Record Setting

In the Recording setup windows, click **OK** to accept the new settings, click **Exit** to exit without saving, and click **Default** to revert back to original factory setting.

Record Setting of IP Camera

i EH5108/EH5108H/EXR5008 series only has 8 channels will be available.

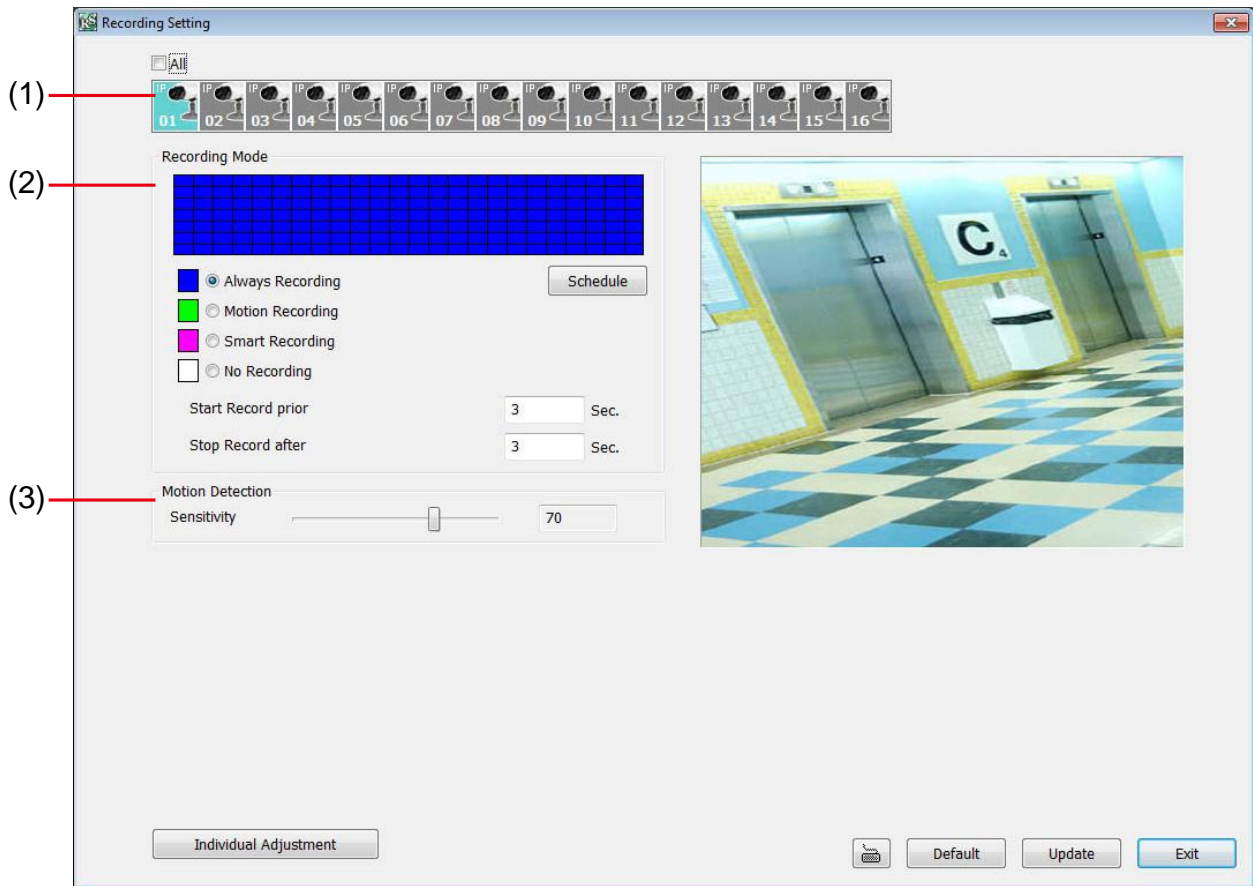

(1) Camera Icons

Select the camera number you want to set the recording setting. To select all the cameras, enable the **ALL** check box. To select more than one camera, **Right click** on the camera icon. To select one camera only, **Left click** on the camera icon. The camera icon turns purple when it is selected.

(2) Recording Mode

The horizontal blocks from 00 to 23 represent the time in 24-hour clock and the vertical block 1 to 7 represent the day in the week block (Sunday to Saturday). To record in full 24 hours and 7 days a week, select the recording mode and click the **☉** button. If you want to only record at a particular time or day, click **Schedule** button and select the **Recording Mode**, and then click on the time or day blocks. When the system starts recording a red triangle mark would appear at the upper left corner of the screen.

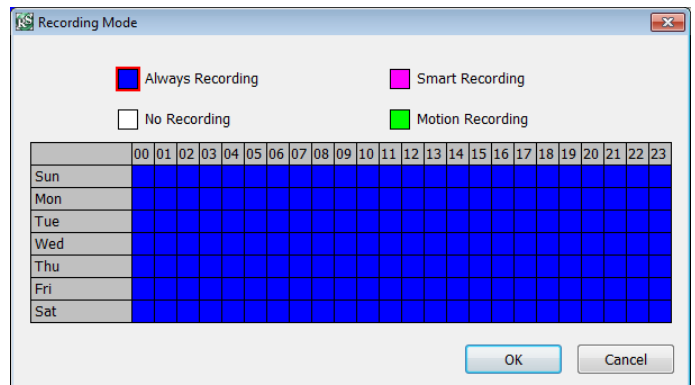

The recording modes are listed below:

- **Always Recording**

Record the video from the selected camera and save it to the designated storage path

- **Motion Recording**

Start recording the video from the selected camera only when the system detects movement. Once a motion is detected, the system automatically saves the previous frames and stop based on the **Start Record Prior** and **Stop Record After** settings.

- **Smart Recording**

Automatically switch to recorded at the maximum frame rate setting once a motion is detected and if there is no motion, it records at the minimum frame rate setting.

- **No Recording**

The system won't do any recording.

(3) Motion Detection

Adjust the sensitivity of the motion detection. The higher the value, the finer the sensitivity is detected. When it detects a motion, a green triangle mark would appear at the upper left corner of the screen.

Record Setting of Analog Camera



EH5108/EH5108H/EXR5008 series only has 8 channels will be available.

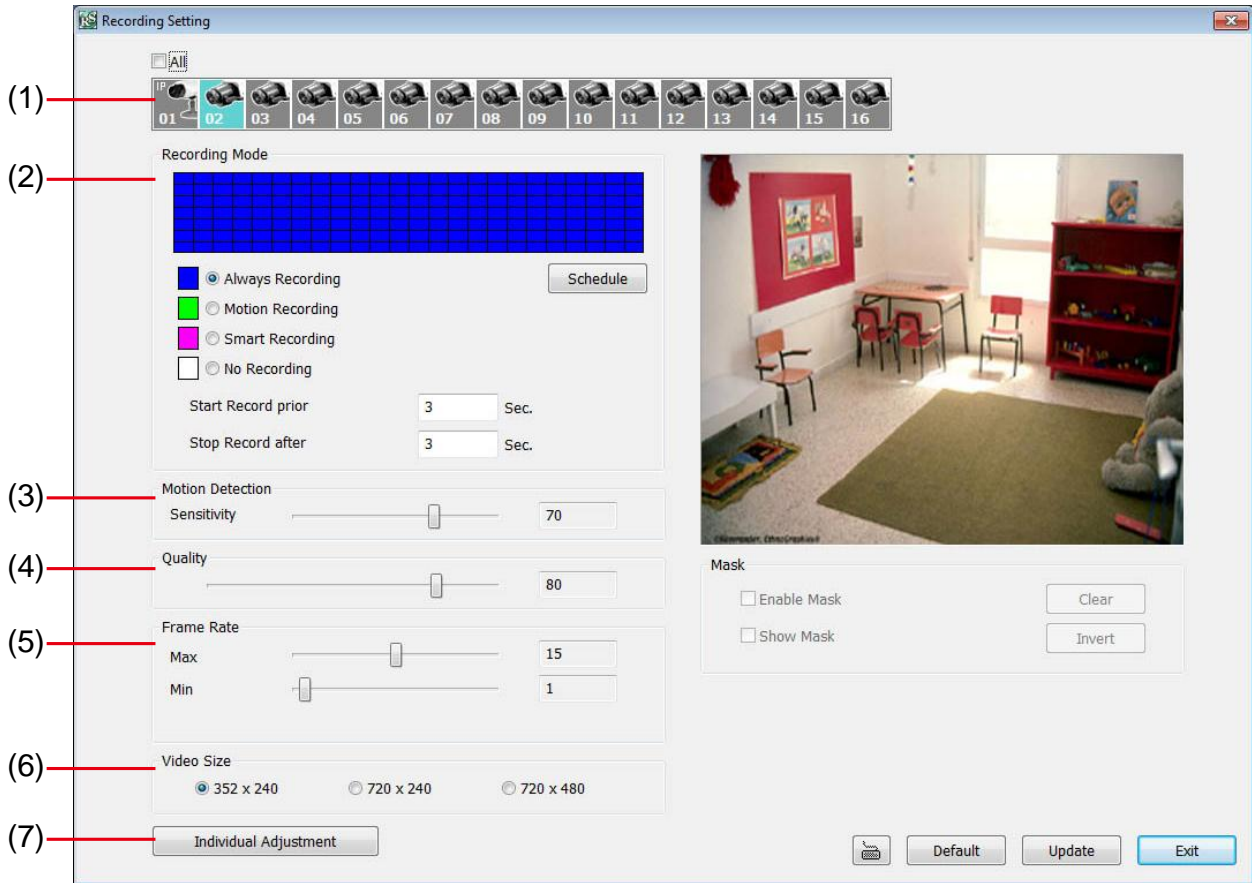

(1) Camera Icons

Select the camera number you want to set the recording setting. To select all the cameras, enable the **ALL** check box. To select more than one camera, **Right click** on the camera icon. To select one camera only, **Left click** on the camera icon. The camera icon turns purple when it is selected.

(2) Recording Mode

The horizontal blocks from 00 to 23 represent the time in 24-hour clock and the vertical block 1 to 7 represent the day in the week block (Sunday to Saturday). To record in full 24 hours and 7 days a week, select the recording mode and click the **Always Recording** button. If you want to only record at a particular time or day, click **Schedule** button and select the **Recording Mode**, and then click on the time or day blocks. When the system starts recording a red triangle mark would appear at the upper left corner of the screen.

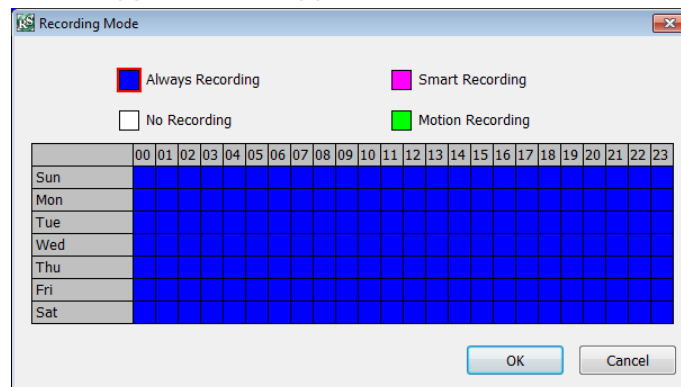

The recording modes are listed below:

- Always Recording

Record the video from the selected camera and save it to the designated storage path

- Motion Recording

Start recording the video from the selected camera only when the system detects movement. Once a motion is detected, the system automatically saves the previous frames and stop based on the **Start Record Prior**

and **Stop Record After** settings.

- **Smart Recording**

Automatically switch to recorded at the maximum frame rate setting once a motion is detected and if there is no motion, it records at the minimum frame rate setting.

- **No Recording**

The system won't do any recording.

(3) Motion Detection

Adjust the sensitivity of the motion detection. The higher the value, the finer the sensitivity is detected. When it detects a motion, a green triangle mark would appear at the upper left corner of the screen.

(4) Quality

Adjust the video quality. The higher the value, the lower the compression level and uses more hard disk space.

(5) Frame Rate

Set the maximum and minimum number of frames to be recorded during motion and motionless state. The frame rate ranges from 01 to 30 for NTSC and 01 to 25 for PAL. The higher the frame rate, it uses more hard disk space.



Always recoding frame rate is depending on max frame rate value.

(6) Video Size

Select the size of the video and click the button. The higher the size, the larger the file it create.

(7) Individual Adjustment

Each camera can adjust video size and frame rate individually. Click **Default** will back to the factory default value. The frame rate usage is shown in **Used** and **Unused** columns by CIF mode.



- Only analog camera can adjust video size and frame rate by channel.
- EH5108/EH5108H/EXR5008 series only has 8 channels will be available.

The screenshot shows a software window titled "Individual Adjustment Setting". At the top, it displays summary statistics for two camera groups: CH01-CH08 and CH09-CH16. Below this, there are three main sections: "Camera", "Video Size", and "Frame Rate". The "Camera" section lists 16 cameras from Camera 01 to Camera 16. The "Video Size" section has radio buttons for "MPEG4 704x576", "CIF", "Half D1", and "D1". The "Frame Rate" section features a slider and a table with "Current" and "Max" values for each camera. At the bottom, there are "Default", "OK", and "Cancel" buttons.

| Group | CIF | Used | Unused |
|-----------|-----|------|--------|
| CH01-CH08 | 480 | 121 | 359 |
| CH09-CH16 | 480 | 120 | 360 |

| Camera | Video Size | Frame Rate (Current / Max) |
|----------------|---------------|----------------------------|
| Camera 01 (IP) | MPEG4 704x576 | 4 / * |
| Camera 02 | CIF | 15 / 30 |
| Camera 03 | CIF | 15 / 30 |
| Camera 04 | CIF | 15 / 30 |
| Camera 05 | CIF | 15 / 30 |
| Camera 06 | CIF | 15 / 30 |
| Camera 07 | CIF | 15 / 30 |
| Camera 08 | CIF | 15 / 30 |
| Camera 09 | CIF | 15 / 30 |
| Camera 10 | CIF | 15 / 30 |
| Camera 11 | CIF | 15 / 30 |
| Camera 12 | CIF | 15 / 30 |
| Camera 13 | CIF | 15 / 30 |
| Camera 14 | CIF | 15 / 30 |
| Camera 15 | CIF | 15 / 30 |
| Camera 16 | CIF | 15 / 30 |

8.2.2.4 Network Setting

In the Network Setting dialog box, click **Update** to accept the new settings, click **Exit** to exit without saving, and click **Default** to revert back to original factory setting. For the network service ports that use by DVR server, please see [Appendix A](#).

The screenshot shows the 'Network Setting' dialog box with the following sections and callouts:

- (1) Server Name: AMH-S161
- (2) Transmitting Cameras: All, 1, 2, 3, 4, 5, 6, 7, 8, 9, 10, 11, 12, 13, 14, 15, 16
- Main Configuration: Server IP (192.168.1.146), Remote Console PORT (5550)
- Remote Update Configuration: PORT (5005)
- WebViewer Configuration: Enable Anonymous Login (unchecked), WebViewer PORT (80)
- Network Time Synchronization: Time Server (empty), Time Zone (GMT+00:00), Automatic synchronize at (00:00), Synchronize Time Right Now button
- Other Configuration: Enable White List (checked), Network Bandwidth Limit (checked), Detail buttons

Buttons at the bottom: Default, Update, Exit.

(1) Server Name

Assign a name for the DVR unit. Alphabet letters and numbers only.

(2) Transmitting Cameras

Select and click on the camera number in the Transmitting Camera section you want to make it accessible via internet using WebViewer, Remote Console, PDA Viewer and JAVAViewer (still image). To select all the cameras, enable the **ALL** check box.



EH5108/EH5108H/EXR5008 series only has 8 channels will be available.

(3) Network Time Synchronization

Adjust the DVR system time same as network time server. Fill in the **Time Server** IP address or domain name. Select the **Time Zone** that DVR is located. And then, mark the **Automatic Synchronize** time to set automatic synchronize time on a daily basis.

(4) Other Configuration

- Enable White List

An access permit list for the remote accessing of DVR server. Enter the IP address and click **Add**. Or, enter a range of IP address and click **Add**. To delete the IP from the list, select the IP and click **Delete** button. To reset the input, click **Clear** button.

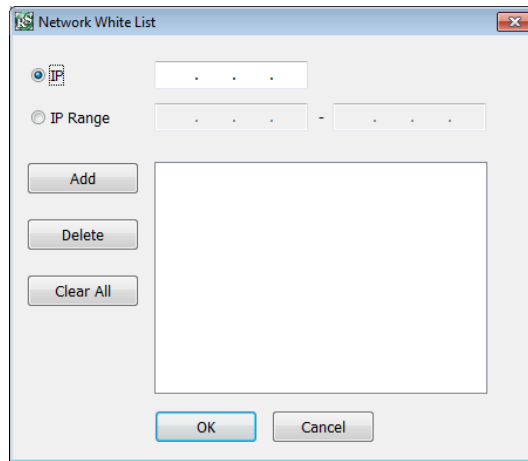

- **Network Bandwidth Limit**

By Channel: Set the network bandwidth by each channel.

All: Set the total network bandwidth consumption limit.

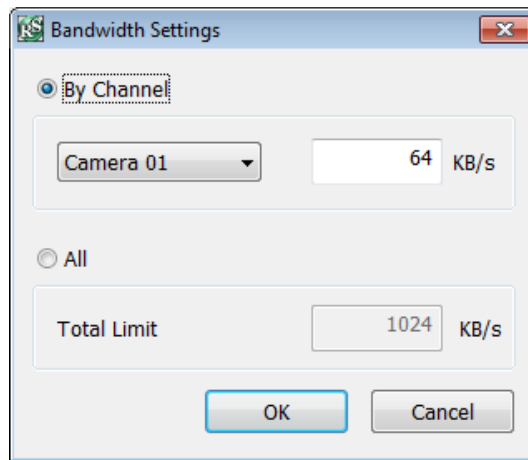

8.2.2.5 Alarm Setting

In the Alarm Setting dialog box, click **Add** to insert and set new alarm setting, click **Delete** to remove the selected alarm setting, click **Update** to save the setting, **Exit** to exit without saving, and **Default** to revert back to original factory setting.

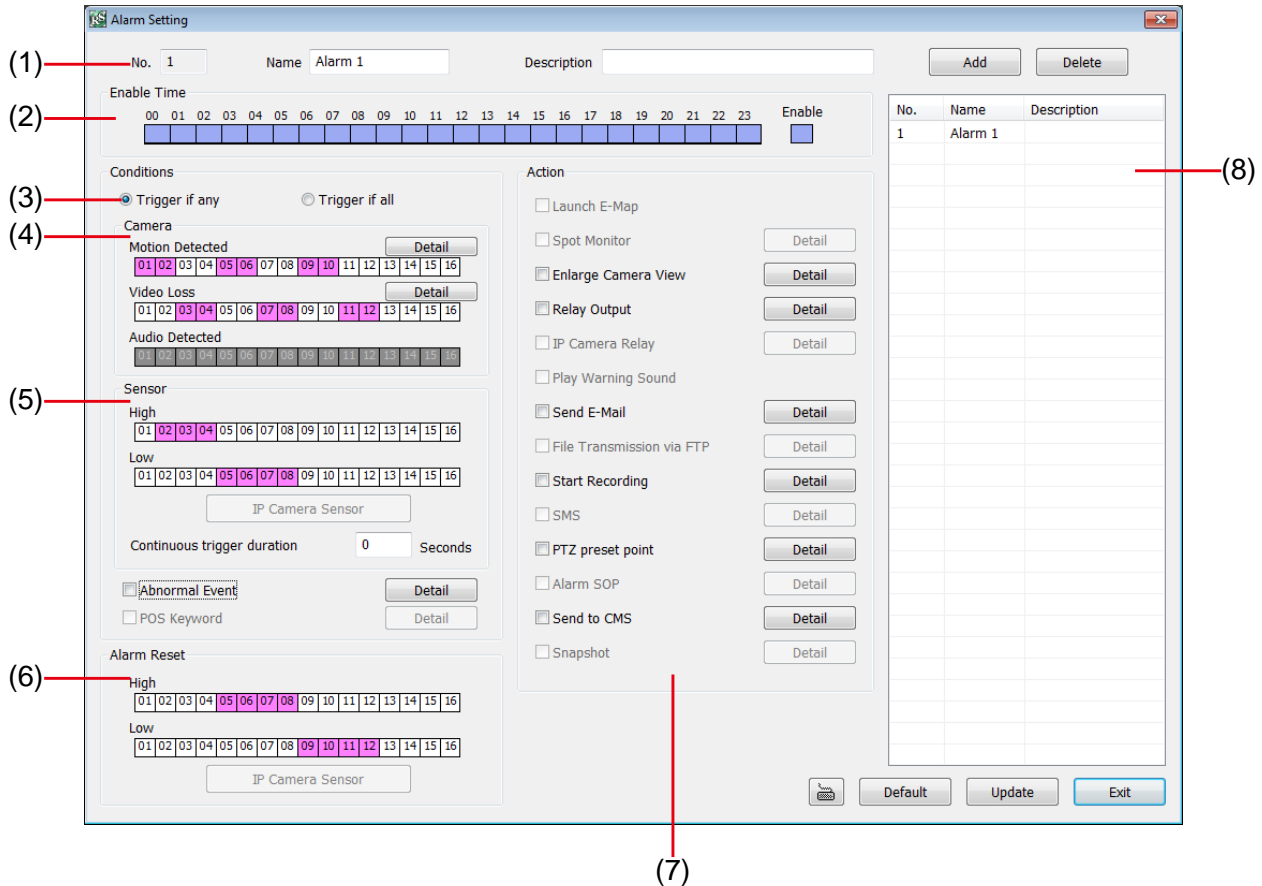

1. Click **Add** to insert and set a new alarm setting. Click the items in the **(8) Alarm Setting List** if you want to modify the alarm setting.
2. In **(1) No./Name/Description** enter alarm name and description. Alarm **No.** will be created by DVR system.
3. In **(2) Enable Time**, the number from 00 to 23 represent the time in 24-hour clock. Select the time and click the block you want to activate or deactivate the alarm function. When it is deactivated the color of the block turns white.
4. In **(3) Conditions**, you can set “**Trigger if any**” to activate if it falls to one of the conditions or “**Trigger if all**” to activate if it falls to all conditions.
5. In **(4) Camera** section, select and click on the camera number (01 to 16) in **Motion Detected** and **Video Loss** to set the condition for the system to alarm.
 - **Motion Detected:** select and click on the camera number (01 to 16) to set the condition for the system to alarm. **Right-click** on the camera number to setup the system to send out the alarm when motion has been detected last the time that user has entered in **Continuous trigger duration**.

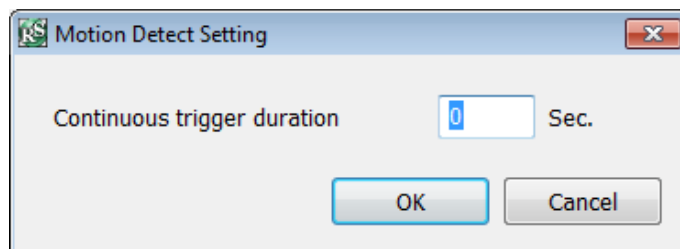

- In **Video Loss**, click the camera number (01 to 16) to set the alarm condition when video is lost. **Right-click** on the camera number (01 to 16) to setup the system to send out the alarm when video has been lost to last the time that user has entered in **Continuous trigger duration**.

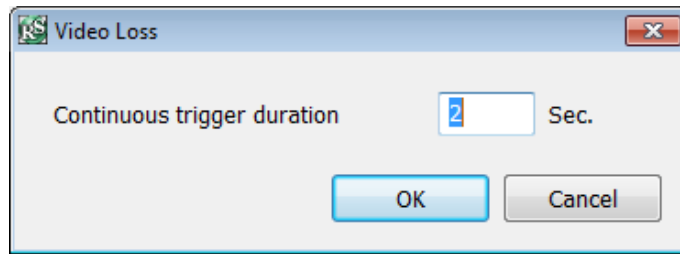

6. In **(5) Sensor**, select and click on the sensor number to set the condition for the system to alarm. If the sensor normal status is high, set the sensor condition to low.
- **Continue trigger duration:** Set a time period that when sensor has been trigger and stay in the same status for that period, then the alarm will be sent out.
 - Enable/disable the **Abnormal Event** check box, to set the condition of the event for system to alarm.

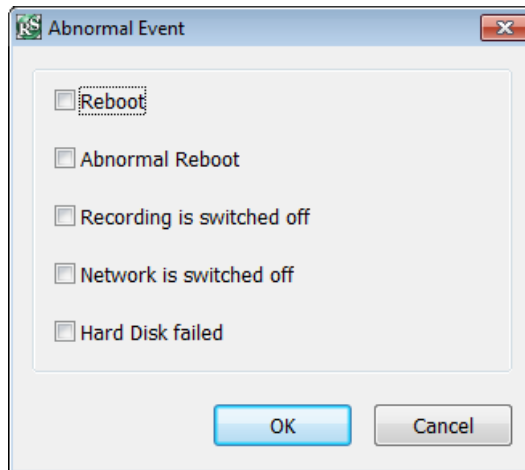

- **Reboot:** when the DVR system reboot without abnormal condition, the system will send out the alarm message.
 - **Abnormal Reboot:** when the DVR system reboot in irregular condition, the system will send out the alarm message.
 - **Recording is switched off:** when the recording has been stopped, the system will send out the alarm message.
 - **Network is switched off:** when the network connection of DVR system is lost, the system will send out the alarm message.
 - **Hard Disk failed:** when the hard disk doesn't work normally, the system will send out the alarm message.
7. In **(6) Alarm Reset**, click the camera number to set the reset condition of alarm. Once alarm is reset, all alarm action will stop at the moment. If the sensor normal status is high, set the alarm reset condition to low.
8. In **(7) Action**, you may now set the alarm action for the system to perform when the alarm condition is activated.

- **Enlarge Camera View**

Switch to only display video in Preview mode from where the alarm is activated.

- a. Select the camera from drop down list to specify which camera video to be enlarged on screen when the alarm is triggered.
- b. **Retrieve time:** set the waiting duration before system switching back to original Preview mode. If the retrieve time is un-mark, the alarm video will keep enlarging until user switch back to Preview mode manually. The retrieve time range is 0~ 600 seconds.

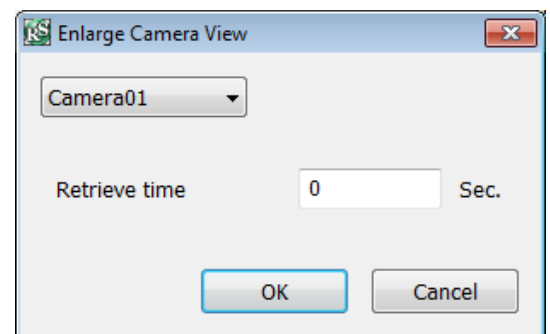

- Relay Output

Set to enable/disable the relay operation when the alarm is activated and to extend additional time in second before it stops the relay operation.

1. Beside the Relay Output check box, click **Detail**.
2. In the Alarm Relay dialog box, select from the available relay list and in the ON column, set to enable/disable the relay operation when the alarm is activated.
3. In the Retrieve time check box, you may enable/disable to extend the relay operation time and set the duration in second.
4. Click **OK** to exit and accept the setting and **Cancel** to exit without saving the setting.

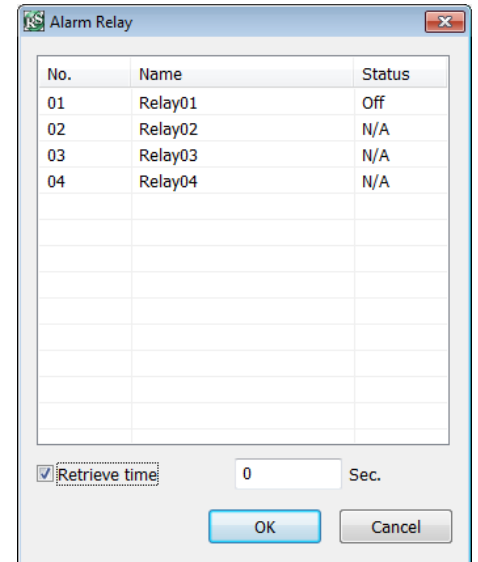

- Send E-mail

Send an electronic text message. Beside the Send Email check box, click **Detail**.

In the E-mail Setting dialog box, click **OK** to exit and save the setting and **Cancel** to exit without saving the setting.

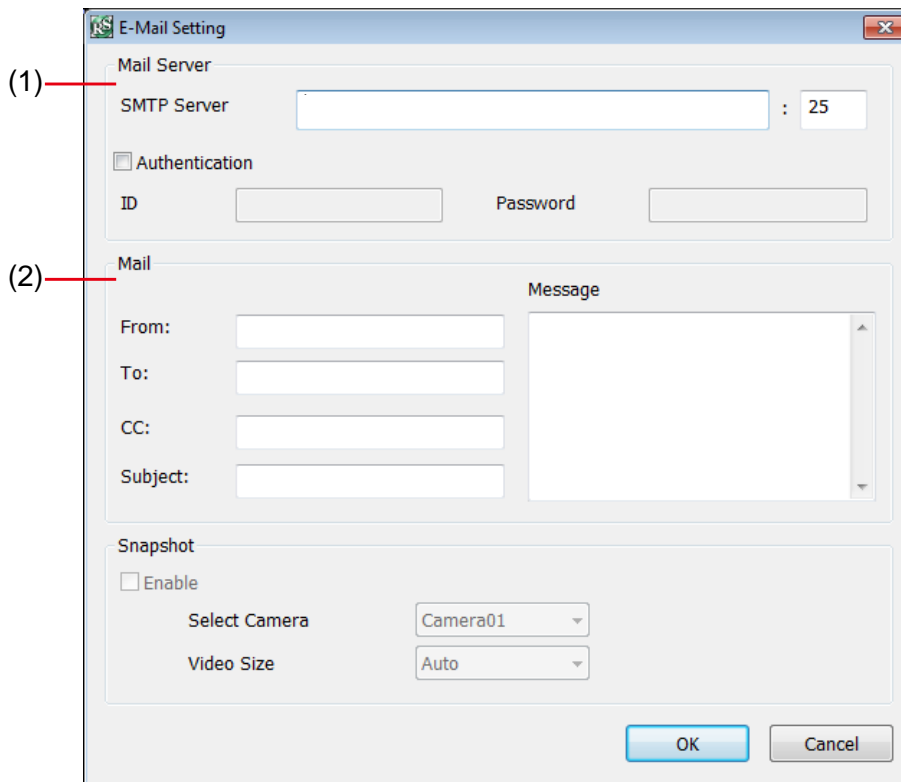

(1) Mail Server

Enter the **SMTP Server** and **port**. If your e-mail system requires user identification, enable **Authentication** check box and enter **ID** and **Password**.

(2) Mail

Fill the mailing information.

From: Enter the sender e-mail address.

To and CC: Enter the recipient email address and separate it with comma or a semicolon (;).

Subject: Enter the message title.

Message: Type the message.

- Start Recording

Record the video from the selected camera.

i EH5108/EH5108H/EXR5008 series only has 8 channels will be available.

1. Beside the Start Recording check box, click **Detail**.
2. In the Alarm Recording Setting dialog box, select the camera to enable/disable video recording. Enable **All** to select all cameras.
3. In the Frame Rate selection, select **As Setting** to record the number of frames based on the Recording Setting.
4. In the **Start Record prior** text box, mark and set the number in second for the program to begin recording after the alarm has been trigger. The time range is 1~10 seconds.
5. In the **Stop Record after** text box, mark and set the number in second for the program to continue recording after the alarm has ended. The time range is 1~999 seconds. If user doesn't mark and set the time, the alarm recording will continue recording until alarm is reset.
6. Click **OK** to accept the new settings and **Cancel** to exit without saving.

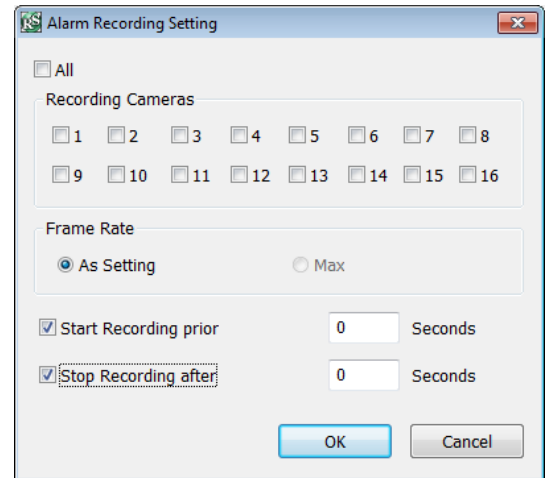

- PTZ preset point

Position the PTZ camera based on the preset point setting. Beside the PTZ preset point check box, click **Detail**. In the Trigger PTZ Preset Setting dialog box, select the PTZ camera number then select the **Enable** check box. Select the position of the PTZ camera when the alarm is activated and ended. For the PTZ camera end point, user can also select on preset position or **Auto Pan** between preset position groups.

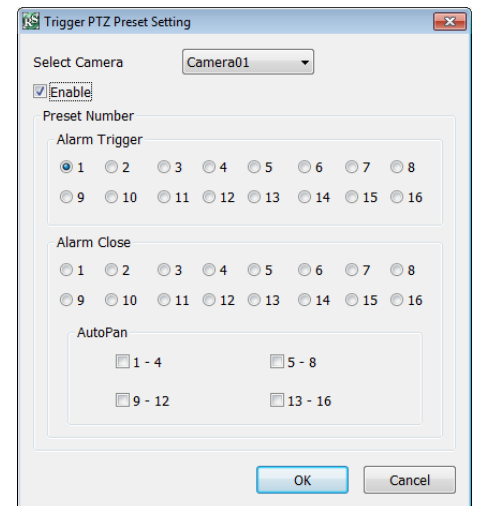

- Send to CMS (Central Management System)

i EH5108/EH5108H/EXR5008 series only has 8 channels will be available.

Enable/disable the selected camera to send video to CMS when the alarm is activated. Beside the Send to CMS check box, click **Detail**. In the CMS Setting, select the camera to enable/disable sending the video to CMS. Enable **All** to select all cameras. Then, click **OK** to accept the new settings and **Cancel** to exit without saving.

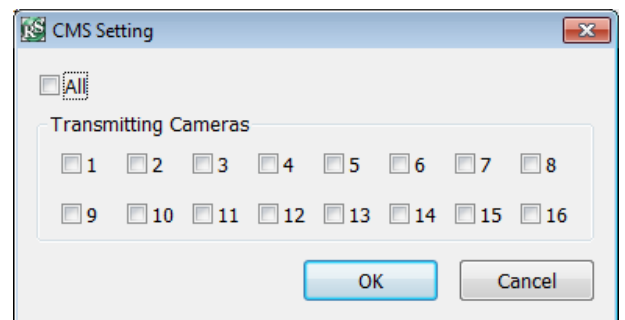

8.3 Remote Backup

Remote Backup is purely for backing up the *.dvr file from the DVR sever. You can select between Auto Backup and Manual Backup. Auto Backup continuously archives one hour of the recorded data at a time, starting from the specified date. As for Manual Backup, it only archives the recorded data of selected date.

i To back up the data, you must have at least 2G hard disk space.

8.3.1 To back up the recoded data from the DVR server:

1. Make sure you are connected to the internet.
2. Click **Start >> Program >> DSS >> Tool >> Remote Backup**
3. To add the DVR server, click **Add**

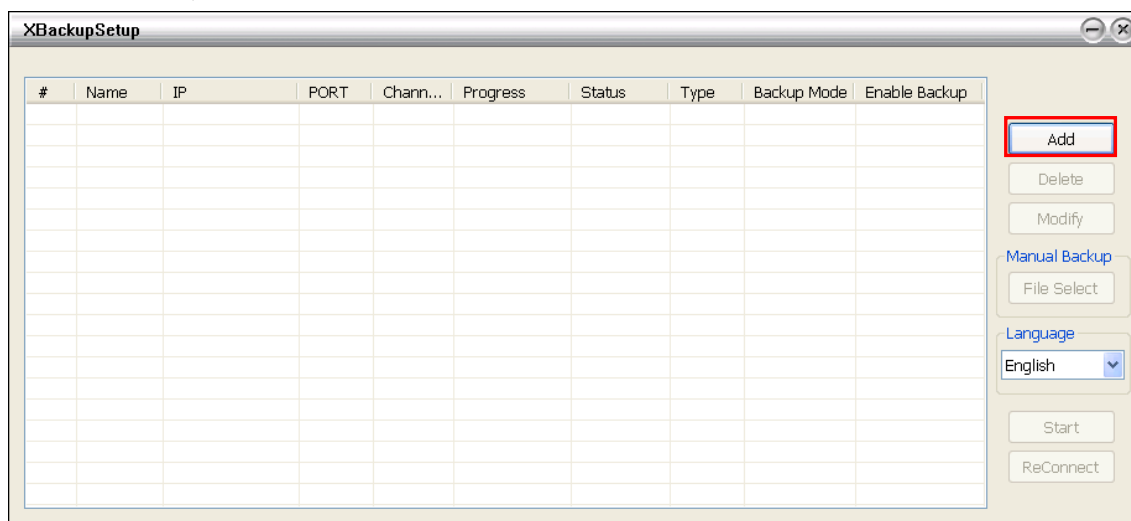

4. In the Add New DVR windows, enter the Name, IP, user ID, and password.

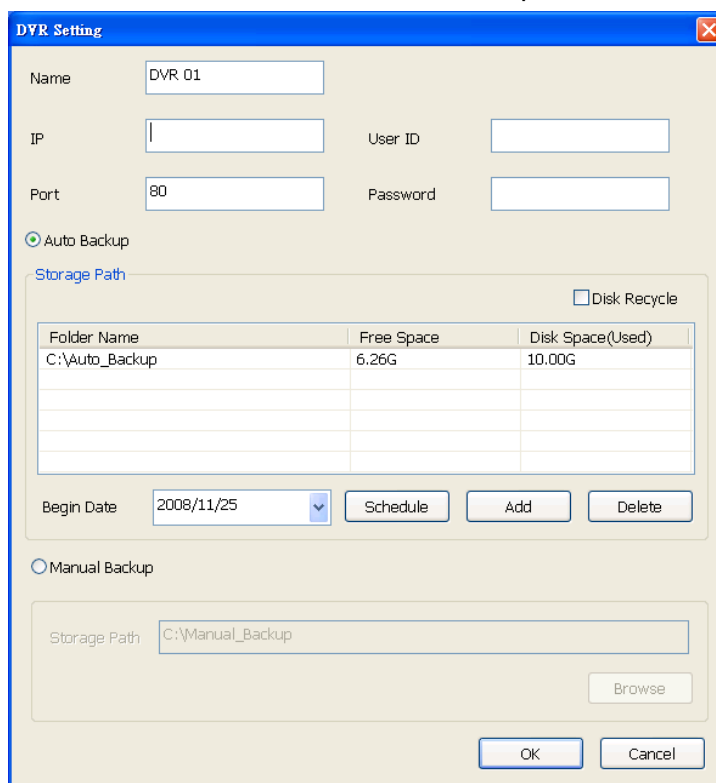

5. Select the Backup mode:

Auto Backup mode: the backup will automatically execute when the setup is completed

- In Begin Date drop down calendar, select the date from where to start
- Click **Add** to set the storage path.
- Click **Delete** to remove the selected storage path.

- Click **Schedule** to select/unselect the time you want to backup. The red block turns white when it is unselected.
- Enable/disable **Disk Recycle** check box, to automatically overwrite the oldest file when there is not enough free space to backup the file.

Manual Backup mode: the backup progress will start when user press the backup button

- Click **File Select** to choose the date, time and camera you want to back up.
- Click **Browse** to set the storage path.

6. Click **OK** to complete the adding DVR server. The added DVR server will display in Remote Backup main windows.

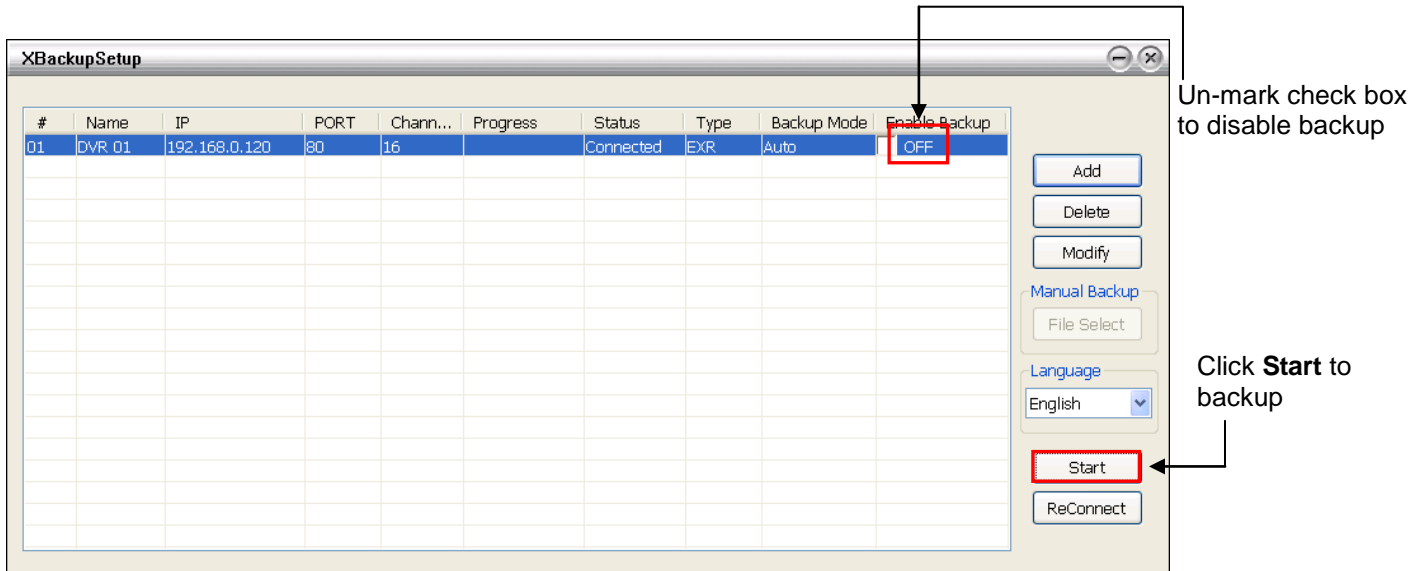

7. Click **Start** to begin backup and click Stop to stop backup progress.

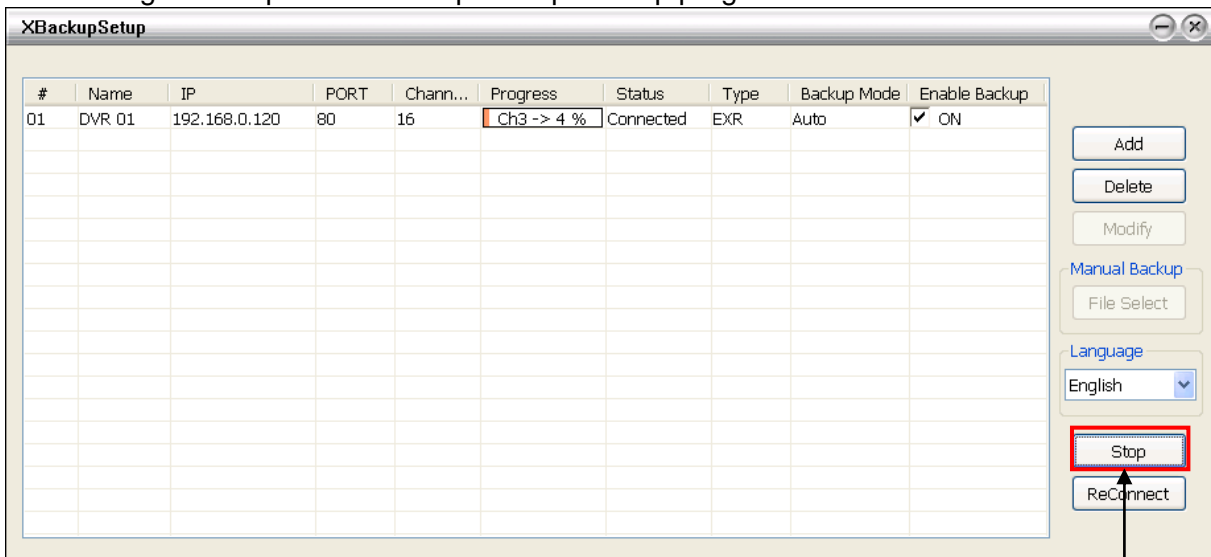

While backup, the **Start** button will turn to **Stop** button

8. For manually backup, click **file select** button and select the DVR to backup.

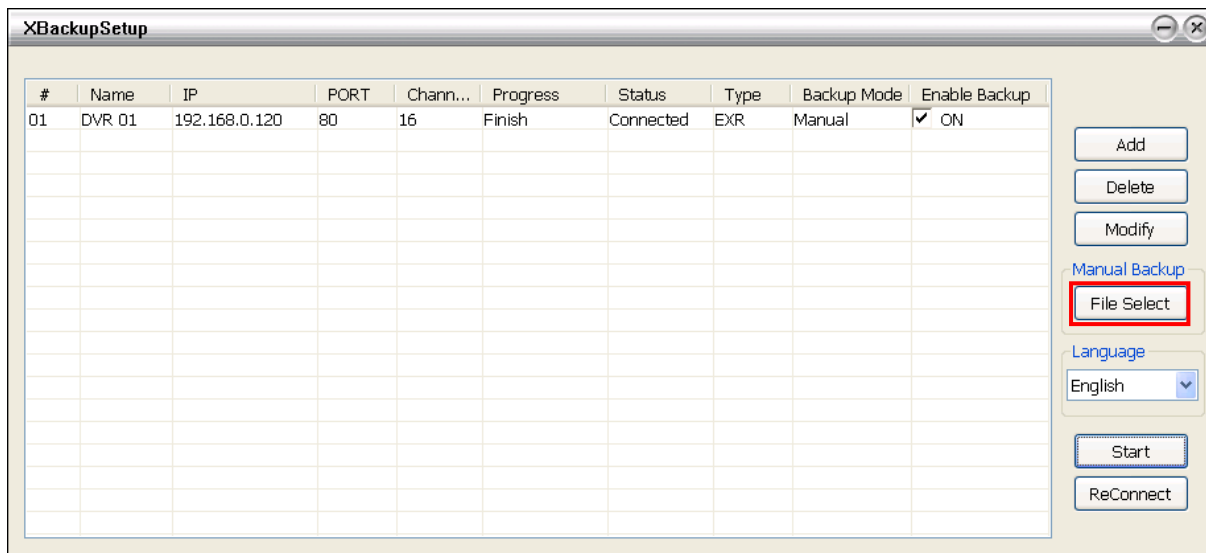

Appendix A Registering Domain Name

DDNS (Dynamic Domain Name Service) is a data query service mainly used on the Internet for translating domain names into Internet addresses. It allows remote clients to intelligently search dynamic servers without any previous enquiring for servers' Internet addresses.

In order to take advantage of this intelligent service, first register your domain name on the following Web site <http://ddns.avers.com.tw>

1. User Login

Browse the website ddns.avers.com.tw with Microsoft IE or Netscape Navigator to access the following dialog.



The 'User Login' dialog box has a blue header with the title 'User Login'. Below the header, there are two input fields: 'CD-Key No.' with a text box and 'Product' with a dropdown menu. At the bottom, there are two buttons: 'OK' and 'Reset'.

2. First input the **MAC Address** in **CD-Key No. column** and select the product name. Then click **OK** to login or **Reset** to clear the previous input.

i To find the MAC address of the DVR, click **Setup > Network** in preview mode UI. And then, click **Setting** of the Main Configuration and user should see the **MAC address** in IP Information section.

3. User Information

Please provide the following user information, **Host Name** (user can choose any name he/she likes except the one violence with other users), **Password**, **E-mail**, **Company**, and **Country**. And then, click **OK** to complete the domain name registration.

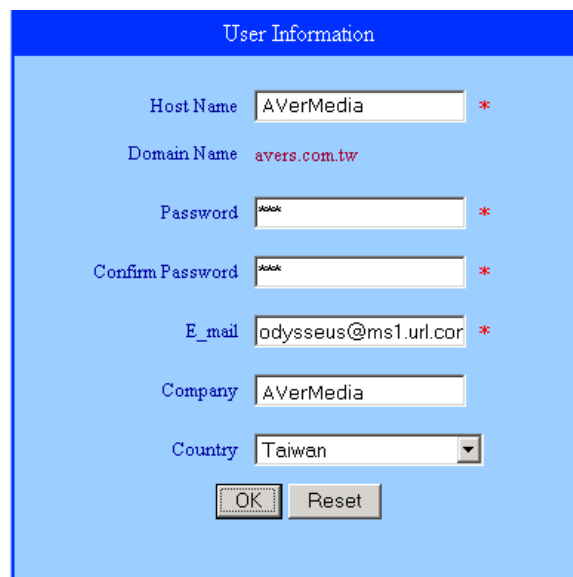

The 'User Information' dialog box has a blue header with the title 'User Information'. Below the header, there are several input fields: 'Host Name' (text box, value: AVerMedia, asterisk), 'Domain Name' (text box, value: avers.com.tw), 'Password' (text box, asterisk), 'Confirm Password' (text box, asterisk), 'E_mail' (text box, value: odysseus@ms1.url.cor, asterisk), 'Company' (text box, value: AVerMedia), and 'Country' (dropdown menu, value: Taiwan). At the bottom, there are two buttons: 'OK' and 'Reset'.

Appendix B Network Service Port

The following table shows the ports that DVR server uses for certain network service.

| | Port# | Variable |
|------------------------------|---------|----------|
| Remote Console | 5550 | Y |
| WebView | 80 | Y |
| CM3000 | 80 | Y |
| Firmware Update | 5005 | Y |
| DVR DDNS (Upload / Download) | 53/1053 | N |

Appendix C Using Functional Keys

The DVR system provides shortcut keys. The table shows the function keys and descriptions.

| Function Keys | Description |
|---------------|---------------------------------|
| Q | Exit System |
| F1 | Display system information |
| F2 | Start recording |
| F3 | Enable network function |
| F4 | Access system settings |
| F5 | Switch to playback mode |
| F6 | Switch to Emap mode |
| F7 | Access PTZ camera control panel |
| F8 | Snapshot |
| F9 | Switch to Full Screen |
| F11 | Switch to AutoScan |

WARRANTY NOTICE

LIMITED WARRANTY

AVerMedia INFORMATION, Inc. warrants this product to be free of defects resulting from faulty manufacture or components under the following terms:

WARRANTY LENGTH

Labor is warranted for (1) one year from the date of purchase

Parts are warranted for (1) one year from the date of purchase

Replacement products will be warranted for the remainder of the one year warranty period or (30) thirty days, whichever is longer

WHO IS PROTECTED

This warranty is enforceable only by the first consumer purchaser

WHAT IS AND IS NOT COVERED

Except as specified below, this warranty covers all defects resulting from faulty manufacturing of this product. The following are not covered by the warranty.

1. Any product on which the serial number has been defaced, modified, or removed
2. Damage, deterioration, or malfunction resulting from:
 - Accident, abuse, misuse, neglect, fire, water, lightning, or other acts of nature, commercial or industrial use, unauthorized product modification, or failure to follow instructions included with the product.
 - Misapplication of service by someone other than the manufacturer's representative
 - Any shipment damages (Claims must be made with carrier)
 - Any other cause which does not relate to a product defect
3. Cartons, cases, batteries, cabinets, tapes, or accessories used with product
4. AVerMedia does not warrant that this product will meet your requirements; it is your responsibility to determine the suitability of this product for your purpose

WHAT WE WILL AND WILL NOT PAY FOR

We will pay labor and material expenses for covered items. However, we will not pay for the following:

1. Removal or installation charges
2. Shipping charges
3. Any incidental charges

EXCLUSION OF DAMAGES

THE MANUFACTURER'S SOLE OBLIGATION AND LIABILITY UNDER THIS WARRANTY IS LIMITED TO THE REPAIR OR REPLACEMENT OF A DEFECTIVE PRODUCT AT OUR OPTION. THE MANUFACTURER SHALL NOT, IN ANY EVENT, BE LIABLE TO THE PURCHASER OR ANY THIRD PARTY FOR ANY INCIDENTAL OR CONSEQUENTIAL DAMAGE (INCLUDING, BUT NOT LIMITED TO, DAMAGES RESULTING FROM INTERRUPTION OF SERVICE AND LOSS OF BUSINESS) OR LIABILITY IN TORT RELATING TO THIS PRODUCT OR RESULTING FROM ITS USE OR POSSESSION.

LIMITATIONS OF IMPLIED WARRANTIES

There are no other oral or written warranties, expressed or implied, including but not limited to those of merchantability or fitness for a particular purpose. Any implied warranties are limited in duration to one year from the date of purchase

STATE LAW AND YOUR WARRANTY

This warranty gives you specific legal rights, and you may also have other rights granted under state law. These rights vary from state to state

CONTACT INFORMATION

Taiwan & International
5F No. 135, Jian Yi Rd., Chung Ho City, Taipei, Taiwan
TEL: 886-2-2226-3630
FAX: 886-2-2226-7241
Web Site: <http://www.avermedia.com>
<http://www.averdigi.com>